

Rexroth IndraControl VCP 11.2

R911311481
Edition 02

Project Planning Manual

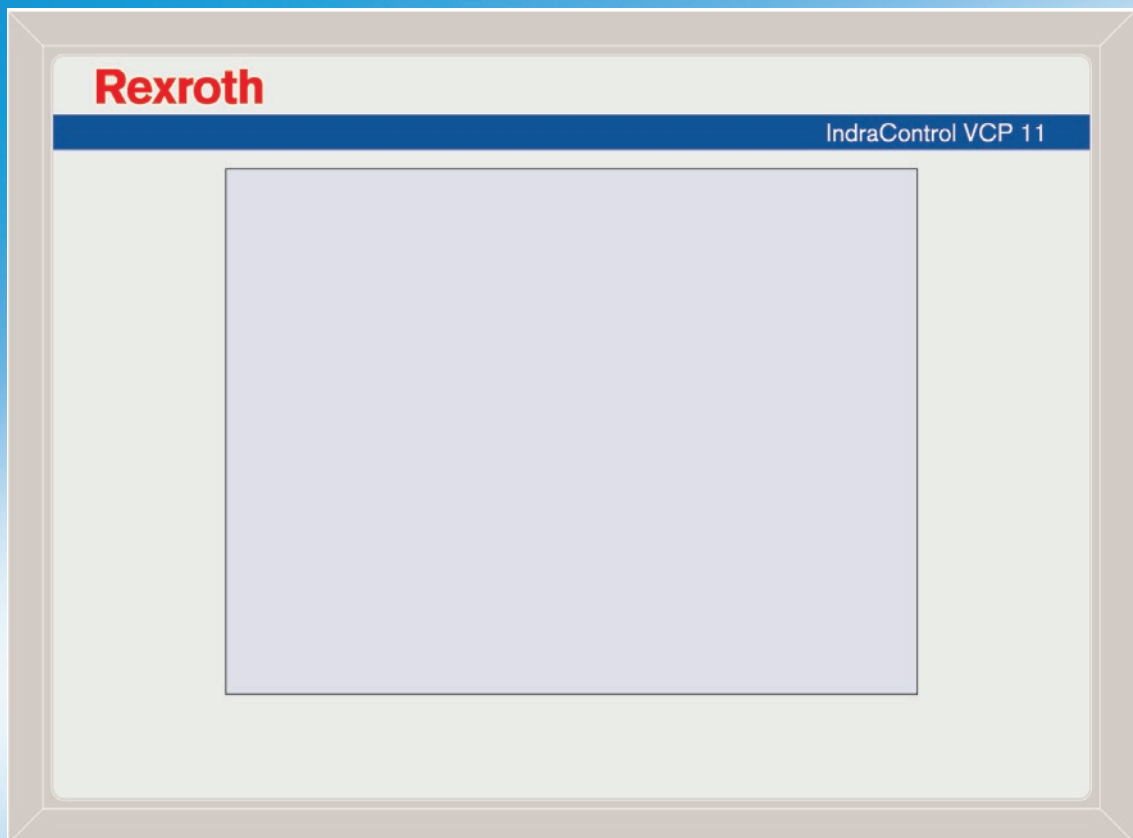

Title	Rexroth IndraControl VCP 11.2
Type of Documentation	Project Planning Manual
Document Typecode	DOK-SUPPL*-VCP*11.2***-PR02-EN-P
Internal File Reference	Document Number, 120-2100-B381-02/EN
Purpose of Documentation	This document serves to describe the different variants of the VCP 11.

Änderungsverlauf

Description	Release Date	Notes
120-2100-B381-01/EN	05.2005	First Edition
120-2100-B381-02/EN	05.2006	Second Edition

Copyright © Bosch Rexroth AG, 2006

Copying this document, giving it to others and the use or communication of the contents thereof without express authority, are forbidden. Offenders are liable for the payment of damages. All rights are reserved in the event of the grant of a patent or the registration of a utility model or design (DIN 34-1).

Validity The specified data is for product description purposes only and may not be deemed to be guaranteed unless expressly confirmed in the contract. All rights are reserved with respect to the content of this documentation and the availability of the product.

Published by Bosch Rexroth AG
Bgm.-Dr.-Nebel-Str. 2
D-97816 Lohr a. Main
Tel.: +49 (0) 93 52 / 40-0
Fax: +49 (0) 93 52 /40-45 85
<http://www.boschrexroth.com/>
Abt.: BRC/EPY (NH)

Note This document has been printed on chlorine-free bleached paper.

Contents

1	Introducing the System	1–1
1.1	Brief Description of the VCP 11	1–1
1.2	Operating System	1–2
1.3	Commissioning	1–2
2	Important Directions for Use.....	2–1
2.1	Appropriate Use	2–1
2.1.1	Introduction	2–1
2.1.2	Areas of Use and Application	2–2
2.2	Inappropriate Use	2–2
3	Safety Instructions for Electric Drives and Controls	3–1
3.1	Introduction	3–1
3.2	Explanations	3–1
3.3	Hazards by Improper Use	3–2
3.4	General Information	3–2
3.5	Protection Against Contact with Electrical Parts.....	3–4
3.6	Protection Against Electric Shock by Protective Low Voltage (PELV)	3–5
3.7	Protection Against Dangerous Movements	3–6
3.8	Protection Against Magnetic and Electromagnetic Fields During Operation and Mounting	3–7
3.9	Protection Against Contact with Hot Parts.....	3–8
3.10	Protection During Handling and Mounting	3–9
3.11	Battery Safety	3–9
3.12	Protection Against Pressurized Systems.....	3–10
4	Technical Data	4–1
4.1	Front Panel and Enclosure	4–1
4.2	Touch Screen and Display	4–1
4.3	Electrical Data	4–2
4.4	Interfaces	4–2
4.5	Central Processing Unit and Memory	4–3
4.6	Connection System	4–3
4.7	Environmental Conditions	4–4
4.8	Applied Standards and Guidelines	4–5
4.9	Compatibility Test	4–6
5	Dimensions.....	5–1
5.1	Installation	5–1
5.1.1	Front Panel Dimensions	5–2
5.1.2	Mounting Cutout	5–3

Contents

5.1.3	Side View with Dimensions	5-4
-------	---------------------------------	-----

6 Display and Operating Components..... 6-1

6.1	Display.....	6-1
6.1.1	Setting the Contrast.....	6-1
6.1.2	Character Attributes.....	6-2
6.1.3	Fonts.....	6-2
6.2	Touch Screen	6-2

7 Interfaces..... 7-1

7.1	Standard Interfaces	7-2
7.1.1	Ethernet (X5)	7-2
7.1.1.1	Pin Assignment.....	7-2
7.1.1.2	Cable	7-2
7.1.1.3	Diagnostics	7-3
7.1.2	USB (X9, X10)	7-3
7.1.2.1	Cable	7-3
7.2	Serial Interfaces	7-4
7.2.1	RS485 (X6-SER1)	7-5
7.2.1.1	Pin Assignment.....	7-5
7.2.1.2	Termination.....	7-6
7.2.2	RS232 (X6-SER1)	7-7
7.2.2.1	Pin Assignment.....	7-7
7.2.2.2	Termination.....	7-7
7.2.3	RS232 (X6-SER2)	7-8
7.2.3.1	Pin Assignment.....	7-8
7.3	Field Bus Interfaces.....	7-9
7.3.1	DeviceNet Slave (X6)	7-9
7.3.1.1	Pin Assignment.....	7-10
7.3.1.2	Cable	7-10
7.3.1.3	Termination.....	7-11
7.3.1.4	Diagnostics	7-11
7.3.2	PROFIBUS DP Slave (X6)	7-12
7.3.2.1	Pin Assignment.....	7-13
7.3.2.2	Cable	7-13
7.3.2.3	Termination.....	7-14
7.3.2.4	Diagnostics	7-14
7.4	Shielding D-SUB Connectors	7-15

8 Maintenance and Installation..... 8-1

8.1	General Information.....	8-1
8.2	Exchange of Hardware Components	8-1
8.3	Data Backup.....	8-1
8.4	Unpacking the Device	8-1
8.5	Identification	8-2
8.6	Connecting the Device	8-3
8.6.1	Supply Voltage 24 V	8-3
8.7	Front Panel.....	8-5
8.8	Fuse	8-5
8.9	Battery	8-6

Contents

8.9.1	Changing the Battery	8-6
8.9.2	Battery Disposal.....	8-6
9	Ordering Information	9-1
9.1	Type Code	9-1
9.2	Accessories	9-2
9.2.1	Ethernet Cable.....	9-3
10	Disposal and Environmental Protection .	10-1
10.1	Disposal.....	10-1
10.1.1	Products.....	10-1
10.1.2	Packaging Materials	10-1
10.2	Environmental Protection	10-1
10.2.1	No Release of Hazardous Substances.....	10-1
10.2.2	Materials Contained in the Products.....	10-1
10.2.2.1	Electronic Devices.....	10-1
10.2.2.2	Motors	10-2
10.2.3	Recycling	10-2
11	List of Figures	11-1
12	Index.....	12-1
13	Service & Support.....	13-1
13.1	Helpdesk.....	13-1
13.2	Service-Hotline	13-1
13.3	Internet	13-1
13.4	Vor der Kontaktaufnahme... - Before contacting us.....	13-2
13.5	Kundenbetreuungsstellen - Sales & Service Facilities ..	13-2
13.5.1	Deutschland - Germany	13-2
13.5.2	Europa (West) - Europe (West)	13-3
13.5.3	Europa (Ost) - Europe (East).....	13-4
13.5.4	Afrika, Asien, Australien (inkl. Pazifischer Raum) - Africa, Asia, Australia (incl. Pacific Rim)	13-5
13.5.5	Nordamerika - North America	13-6
13.5.6	Südamerika - South America.....	13-6

Contents

Introducing the System

1 Introducing the System

1.1 Brief Description of the VCP 11

The small operator terminal VCP 25 is a machine operator terminal which can initiate functions in the machine as defined in the application.

Special features of the Device are its compact design and the seal running around the rear. Thus, it is suitable for various applications. Furthermore, every mounting position is possible.

Depending on the variant, the small operator terminal is equipped either with two serial standard interfaces or with a field bus interface.

The front panel with touch screen allows to operate the application software via the touch-sensitive surface of the display without keyboard.

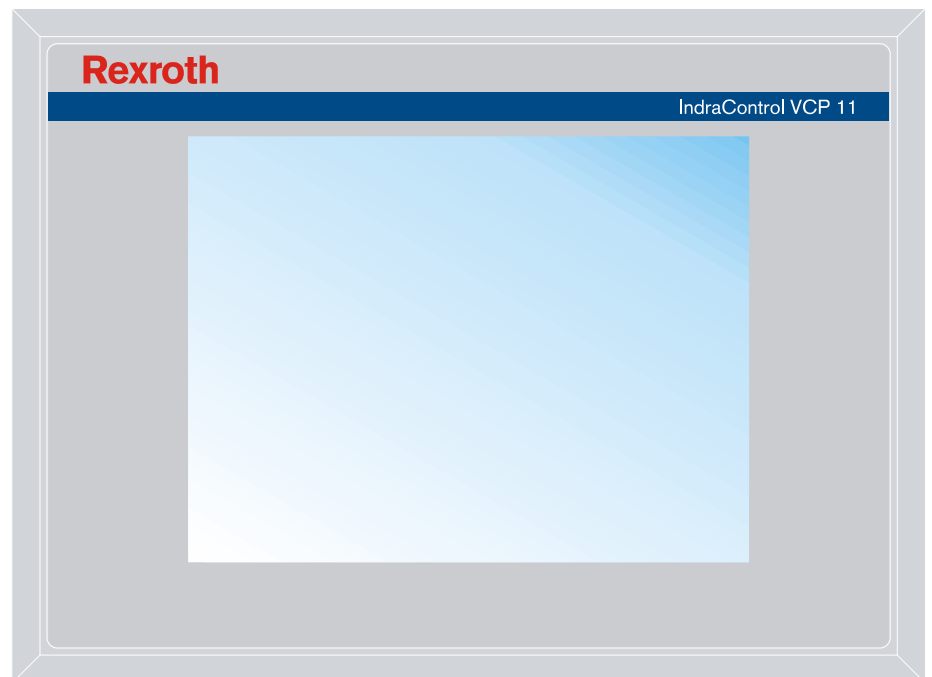

Fig. 1-1: VCP 11 with touch screen

Introducing the System

1.2 Operating System

The Windows CE operating system is installed on the small operator terminal.

1.3 Commissioning

Mount the device properly (for more information, see chapter Dimensions). Then connect the device to the voltage supply and to the control unit or the field bus system, if required.

Important Directions for Use

2 Important Directions for Use

2.1 Appropriate Use

2.1.1 Introduction

Rexroth products represent state-of-the-art developments and manufacturing. They are tested prior to delivery to ensure operating safety and reliability.

The products may only be used in the manner that is defined as appropriate. If they are used in an inappropriate manner, then situations can develop that may lead to property damage or injury to personnel.



Bosch Rexroth, as manufacturer, is not liable for any damages resulting from inappropriate use. In such cases, the guarantee and the right to payment of damages resulting from inappropriate use are forfeited. The user alone carries all responsibility of the risks.

Before using Rexroth products, make sure that all the pre-requisites for appropriate use of the products are satisfied:

- Personnel that in any way, shape or form uses our products must first read and understand the relevant safety instructions and be familiar with appropriate use.
- If the product takes the form of hardware, then they must remain in their original state, in other words, no structural changes are permitted. It is not permitted to decompile software products or alter source codes.
- Do not mount damaged or faulty products or use them in operation.
- Make sure that the products have been installed in the manner described in the relevant documentation.

Important Directions for Use

2.1.2 Areas of Use and Application

The small operator terminal VCP 11 made by Bosch Rexroth allows to operate and control machines and installations and serves to visualize the information on the machine/installation to be operated required by the user.



The VCP 11 may only be used with the accessories and parts specified in this document. If a component has not been specifically named, then it may not be either mounted or connected. The same applies to cables and lines. Operation is only permitted in the specified configurations and combinations of components using the software and firmware as specified in the relevant function descriptions.

The small operator terminals VCP 11 have been developed for use in single or multiple-axis control tasks.

Typical applications of the VCP 11 are:

- Handling and assembly systems,
- Packaging machines,
- Printing and paper processing machines and
- Machine tools.

The VCP 11 may only be operated under the assembly, installation and ambient conditions as described here (temperature, system of protection, humidity, EMC requirements, etc.) and in the position specified.

2.2 Inappropriate Use

Using the small operator terminal outside of the above-referenced areas of application or under operating conditions other than described in the document and the technical data specified is defined as "inappropriate use".

The small operator terminal may not be used, if

- they are subject to operating conditions that do not meet the above specified ambient conditions. This includes, for example, operation under water, in the case of extreme temperature fluctuations or extremely high maximum temperatures or if
- Bosch Rexroth has not specifically released them for that intended purpose. Please note the specifications outlined in the general Safety Guidelines!

3 Safety Instructions for Electric Drives and Controls

3.1 Introduction

Read these instructions before the initial startup of the equipment in order to eliminate the risk of bodily harm or material damage. Follow these safety instructions at all times. Do not attempt to install or start up this equipment without first reading all documentation provided with the product. Read and understand these safety instructions and all user documentation of the equipment prior to working with the equipment at any time. If you do not have the user documentation for your equipment, contact your local Bosch Rexroth representative to send this documentation immediately to the person or persons responsible for the safe operation of this equipment. If the equipment is resold, rented or transferred or passed on to others, then these safety instructions must be delivered with the equipment.



WARNING

Improper use of this equipment, failure to follow the safety instructions in this document or tampering with the product, including disabling of safety devices, may result in material damage, bodily harm, electric shock or even death!

3.2 Explanations

The safety instructions describe the following degrees of hazard seriousness in compliance with ANSI Z535. The degree of hazard seriousness informs about the consequences resulting from non-compliance with the safety instructions.



Warning symbol	Signal word and degree of hazard seriousness according to ANSI
	DANGER Death or severe bodily harm will occur.
	WARNING Death or severe bodily harm may occur.
	CAUTION Bodily harm or material damage may occur.

Fig. 3-1: Hazard classification (according to ANSI Z535)

3.3 Hazards by Improper Use

**DANGER**

High voltage and high discharge current! Danger to life or severe bodily harm by electric shock!

**DANGER**

Dangerous movements! Danger to life, severe bodily harm or material damage by unintentional motor movements!

**WARNING**

High electrical voltage due to wrong connections! Danger to life or bodily harm by electric shock!

**WARNING**

Health hazard for persons with heart pacemakers, metal implants and hearing aids in proximity to electrical equipment!

**CAUTION**

Surface of machine housing could be extremely hot! Danger of injury! Danger of burns!

**CAUTION**

Risk of injury due to improper handling! Bodily harm caused by crushing, shearing, cutting and mechanical shock or incorrect handling of pressurized systems!

**CAUTION**

Risk of injury due to incorrect handling of batteries!

3.4 General Information

- Bosch Rexroth AG is not liable for damages resulting from failure to observe the warnings provided in this documentation.
- Read the operating, maintenance and safety instructions in your language before starting up the machine. If you find that you cannot completely understand the documentation for your product, please ask your supplier to clarify.
- Proper and correct transport, storage, assembly and installation as well as care in operation and maintenance are prerequisites for optimal and safe operation of this equipment.
- Only persons who are trained and qualified for the use and operation of the equipment may work on this equipment or within its proximity.

Safety Instructions for Electric Drives and Controls

- Furthermore, they must be trained, instructed and qualified to switch electrical circuits and equipment on and off in accordance with technical safety regulations, to ground them and to mark them according to the requirements of safe work practices. They must have adequate safety equipment and be trained in first aid.
- Only use spare parts and accessories approved by the manufacturer.
- Follow all safety regulations and requirements for the specific application as practiced in the country of use.
- The equipment is designed for installation in industrial machinery.
- The ambient conditions given in the product documentation must be observed.
- Use only safety features and applications that are clearly and explicitly approved in the Project Planning Manual.
- For example, the following areas of use are not permitted: construction cranes, elevators used for people or freight, devices and vehicles to transport people, medical applications, refinery plants, transport of hazardous goods, nuclear applications, applications sensitive to high frequency, mining, food processing, control of protection equipment (also in a machine).
- The information given in the documentation of the product with regard to the use of the delivered components contains only examples of applications and suggestions.

The machine and installation manufacturer must

- make sure that the delivered components are suited for his individual application and check the information given in this documentation with regard to the use of the components,
- make sure that his application complies with the applicable safety regulations and standards and carry out the required measures, modifications and complements.
- Startup of the delivered components is only permitted once it is sure that the machine or installation in which they are installed complies with the national regulations, safety specifications and standards of the application.
- Operation is only permitted if the national EMC regulations for the application are met.
- The instructions for installation in accordance with EMC requirements can be found in the documentation "EMC in Drive and Control Systems".
- Technical data, connections and operational conditions are specified in the product documentation and must be followed at all times.

The machine or installation manufacturer is responsible for compliance with the limiting values as prescribed in the national regulations.

- Technical data, connections and operational conditions are specified in the product documentation and must be followed at all times.

3.5 Protection Against Contact with Electrical Parts



This section refers to equipment and drive components with voltages above 50 Volts.

Touching live parts with voltages of 50 Volts and more with bare hands or conductive tools or touching ungrounded housings can be dangerous and cause electric shock. In order to operate electrical equipment, certain parts must unavoidably have dangerous voltages applied to them.



DANGER

High electrical voltage! Danger to life, severe bodily harm by electric shock!

- Only those trained and qualified to work with or on electrical equipment are permitted to operate, maintain or repair this equipment.
- Follow general construction and safety regulations when working on high voltage installations.
- Before switching on power the ground wire must be permanently connected to all electrical units according to the connection diagram.
- Do not operate electrical equipment at any time, even for brief measurements or tests, if the ground wire is not permanently connected to the points of the components provided for this purpose.
- Before working with electrical parts with voltage higher than 50 V, the equipment must be disconnected from the mains voltage or power supply. Make sure the equipment cannot be switched on again unintended.
- The following should be observed with electrical drive and filter components:

Wait five (5) minutes after switching off power to allow capacitors to discharge before beginning to work. Measure the voltage on the capacitors before beginning to work to make sure that the equipment is safe to touch.

- Never touch the electrical connection points of a component while power is turned on.
 - Install the covers and guards provided with the equipment properly before switching the equipment on. Prevent contact with live parts at any time.
 - A residual-current-operated protective device (RCD) must not be used on electric drives! Indirect contact must be prevented by other means, for example, by an overcurrent protective device.
 - Electrical components with exposed live parts and uncovered high voltage terminals must be installed in a protective housing, for example, in a control cabinet.
-

To be observed with electrical drive and filter components:

**DANGER**

High electrical voltage on the housing! High leakage current! Danger to life, danger of injury by electric shock!

- Connect the electrical equipment, the housings of all electrical units and motors permanently with the safety conductor at the ground points before power is switched on. Look at the connection diagram. This is even necessary for brief tests.
 - Connect the safety conductor of the electrical equipment always permanently and firmly to the supply mains. Leakage current exceeds 3.5 mA in normal operation.
 - Use a copper conductor with at least 10 mm² cross section over its entire course for this safety conductor connection!
 - Prior to startups, even for brief tests, always connect the protective conductor or connect with ground wire. Otherwise, high voltages can occur on the housing that lead to electric shock.
-

3.6 Protection Against Electric Shock by Protective Low Voltage (PELV)

All connections and terminals with voltages between 0 and 50 Volts on Rexroth products are protective low voltages designed in accordance with international standards on electrical safety.

**WARNING**

High electrical voltage due to wrong connections! Danger to life, bodily harm by electric shock!

- Only connect equipment, electrical components and cables of the protective low voltage type (PELV = Protective Extra Low Voltage) to all terminals and clamps with voltages of 0 to 50 Volts.
 - Only electrical circuits may be connected which are safely isolated against high voltage circuits. Safe isolation is achieved, for example, with an isolating transformer, an opto-electronic coupler or when battery-operated.
-

3.7 Protection Against Dangerous Movements

Dangerous movements can be caused by faulty control of the connected motors. Some common examples are:

- improper or wrong wiring of cable connections
- incorrect operation of the equipment components
- wrong input of parameters before operation
- malfunction of sensors, encoders and monitoring devices
- defective components
- software or firmware errors

Dangerous movements can occur immediately after equipment is switched on or even after an unspecified time of trouble-free operation.

The monitoring in the drive components will normally be sufficient to avoid faulty operation in the connected drives. Regarding personal safety, especially the danger of bodily injury and material damage, this alone cannot be relied upon to ensure complete safety. Until the integrated monitoring functions become effective, it must be assumed in any case that faulty drive movements will occur. The extent of faulty drive movements depends upon the type of control and the state of operation.



DANGER

Dangerous movements! Danger to life, risk of injury, severe bodily harm or material damage!

- Ensure personal safety by means of qualified and tested higher-level monitoring devices or measures integrated in the installation. Unintended machine motion is possible if monitoring devices are disabled, bypassed or not activated.

Pay attention to unintended machine motion or other malfunction in any mode of operation.

- Keep free and clear of the machine's range of motion and moving parts. Possible measures to prevent people from accidentally entering the machine's range of motion:
 - use safety fences
 - use safety guards
 - use protective coverings
 - install light curtains or light barriers

Safety Instructions for Electric Drives and Controls

- Fences and coverings must be strong enough to resist maximum possible momentum, especially if there is a possibility of loose parts flying off.
- Mount the emergency stop switch in the immediate reach of the operator. Verify that the emergency stop works before startup. Don't operate the machine if the emergency stop is not working.
- Isolate the drive power connection by means of an emergency stop circuit or use a starting lockout to prevent unintentional start.
- Make sure that the drives are brought to a safe standstill before accessing or entering the danger zone. Safe standstill can be achieved by switching off the power supply contactor or by safe mechanical locking of moving parts.
- Secure vertical axes against falling or dropping after switching off the motor power by, for example:
 - mechanically securing the vertical axes
 - adding an external braking/ arrester/ clamping mechanism
 - ensuring sufficient equilibration of the vertical axes

The standard equipment motor brake or an external brake controlled directly by the drive controller are not sufficient to guarantee personal safety!

- Disconnect electrical power to the equipment using a master switch and secure the switch against reconnection for:
 - maintenance and repair work
 - cleaning of equipment
 - long periods of discontinued equipment use
- Prevent the operation of high-frequency, remote control and radio equipment near electronics circuits and supply leads. If the use of such equipment cannot be avoided, verify the system and the installation for possible malfunctions in all possible positions of normal use before initial startup. If necessary, perform a special electromagnetic compatibility (EMC) test on the installation.

3.8 Protection Against Magnetic and Electromagnetic Fields During Operation and Mounting

Magnetic and electromagnetic fields generated near current-carrying conductors and permanent magnets in motors represent a serious health hazard to persons with heart pacemakers, metal implants and hearing aids.

**WARNING**

Health hazard for persons with heart pacemakers, metal implants and hearing aids in proximity to electrical equipment!

- Persons with heart pacemakers, hearing aids and metal implants are not permitted to enter the following areas:
 - Areas in which electrical equipment and parts are mounted, being operated or started up.
 - Areas in which parts of motors with permanent magnets are being stored, operated, repaired or mounted.
 - If it is necessary for a person with a heart pacemaker to enter such an area, then a doctor must be consulted prior to doing so. Heart pacemakers that are already implanted or will be implanted in the future, have a considerable variation in their electrical noise immunity. Therefore there are no rules with general validity.
 - Persons with hearing aids, metal implants or metal pieces must consult a doctor before they enter the areas described above. Otherwise, health hazards will occur.
-

3.9 Protection Against Contact with Hot Parts

**CAUTION**

Housing surfaces could be extremely hot! Danger of injury! Danger of burns!

- Do not touch housing surfaces near sources of heat! Danger of burns!
 - After switching the equipment off, wait at least ten (10) minutes to allow it to cool down before touching it.
 - Do not touch hot parts of the equipment, such as housings with integrated heat sinks and resistors. Danger of burns!
-

3.10 Protection During Handling and Mounting

Under certain conditions, incorrect handling and mounting of parts and components may cause injuries.

**CAUTION**

Risk of injury by incorrect handling! Bodily harm caused by crushing, shearing, cutting and mechanical shock!

- Observe general installation and safety instructions with regard to handling and mounting.
 - Use appropriate mounting and transport equipment.
 - Take precautions to avoid pinching and crushing.
 - Use only appropriate tools. If specified by the product documentation, special tools must be used.
 - Use lifting devices and tools correctly and safely.
 - For safe protection wear appropriate protective clothing, e.g. safety glasses, safety shoes and safety gloves.
 - Never stand under suspended loads.
 - Clean up liquids from the floor immediately to prevent slipping.
-

3.11 Battery Safety

Batteries contain reactive chemicals in a solid housing. Inappropriate handling may result in injuries or material damage.

**CAUTION**

Risk of injury by incorrect handling!

- Do not attempt to reactivate discharged batteries by heating or other methods (danger of explosion and cauterization).
 - Never charge non-chargeable batteries (danger of leakage and explosion).
 - Never throw batteries into a fire.
 - Do not dismantle batteries.
 - Do not damage electrical components installed in the equipment.
-



Be aware of environmental protection and disposal! The batteries contained in the product should be considered as hazardous material for land, air and sea transport in the sense of the legal requirements (danger of explosion). Dispose batteries separately from other waste. Observe the legal requirements in the country of installation.

3.12 Protection Against Pressurized Systems

Certain motors and drive controllers, corresponding to the information in the respective Project Planning Manual, must be provided with pressurized media, such as compressed air, hydraulic oil, cooling fluid and cooling lubricant supplied by external systems. Incorrect handling of the supply and connections of pressurized systems can lead to injuries or accidents. In these cases, improper handling of external supply systems, supply lines or connections can cause injuries or material damage.



CAUTION

Danger of injury by incorrect handling of pressurized systems!

- Do not attempt to disassemble, to open or to cut a pressurized system (danger of explosion).
- Observe the operation instructions of the respective manufacturer.
- Before disassembling pressurized systems, release pressure and drain off the fluid or gas.
- Use suitable protective clothing (for example safety glasses, safety shoes and safety gloves)
- Remove any fluid that has leaked out onto the floor immediately.



Environmental protection and disposal! The media used in the operation of the pressurized system equipment may not be environmentally compatible. Media that are damaging the environment must be disposed separately from normal waste. Observe the legal requirements in the country of installation.

Technical Data

4 Technical Data

4.1 Front Panel and Enclosure

Front Panel and Enclosure	
Enclosure	Steel Sheet, Galvanized
Front Panel	Aluminum, anodized natural finish 96 mm x 130 mm x 5 mm (3.78" x 5.118" x 0.196") - (H x W x D)
Front Panel Cover	Polyester Foil
Seal	Circumferential Rubber Seal on the Rear
Mounting Cutout	88 mm x 122 mm (3.465" x 4.803") - (H x W)
Mounting Depth	About 55 mm (2.165")
Degrees of Protection	Front: IP65 Rear: IP20
Total Weight	About 500 g

4.2 Touch Screen and Display

Touch Screen	
Type	Analog Resistive, 4-Wire Technology
Activation Force	15 g (Standard) With R8 HS60 Silicon Rubber
Durability	No Damages or Malfunctions after 3 Million Strokes under the following conditions: Stroke Element: R8, HS40 Silicon Rubber Stroke Force: 150 g Stroke Frequency: 3 Hz

Display	
Type	FSTN
Resolution	320 x 240 Pixels
Colors	5 Shades of Gray
Reading Angle	90 °

Technical Data

Display	
Contrast Setting	Temperature Compensated
Half-Life Backlighting	30,000 h
Display Area (H x W)	57.6 mm x 76.8 mm (2.268" x 3.024")

4.3 Electrical Data

Electrical Data	
Supply Voltage	24 V DC (SELV in Accordance with DIN EN 61131)
Residual Ripple	10 % Maximum
Minimum Voltage	18 V
Maximum Voltage	30 V
Power Consumption (Typical at 24 V)	0.25 A
Power Consumption (Maximum)	0.35 A
Connected Load	6 W
Fuse	Semiconductor Fuse, Self-resetting
Protection Against Polarity Reversal	Integrated

4.4 Interfaces

Ethernet	
X5 Ethernet	10/100 Base-T

Serial Interfaces	
Variable Baud Rates and Data Formats	
X6 SER1 RS485	In Accordance With DIN 66259-4 Transmission Length: 0 - 1200 m (up to 3937 feet), Twisted Pair Wire, Shielded Galvanically Isolated
X6 SER1 RS232 / X6 SER2 RS232	In Accordance With DIN 66259 T1, CCITT V.28 Transmission Length: 0 - 15 m (up to 49.212 feet), Conductors Layered in Strands, Shielded X6 SER1: Galvanically Isolated X6 SER2: Galvanically Not Isolated

Technical Data

Field Bus Interfaces	
Variable Baud Rates and Data Formats	
X6 PROFIBUS DP	Galvanically Isolated
X6 DeviceNet	Galvanically Isolated

USB	
Corresponds to the "Universal Serial Bus Specification Rev. 2.0"	
X9, X10 Host	Min.: 1.5 Mbit/s Max.: 12 Mbit/s Max. Output Current 100 mA per Output

4.5 Central Processing Unit and Memory

Central Processing Unit	
Central Processing Unit	RISC ARM9
Clock Frequency	200 MHz
Other Features	Watchdog Timer, Real-Time Clock, Battery Monitoring

Memory	
Application Memory	3 MByte
Flash	16 MByte
SDRAM	32 MByte
SRAM	512 KByte

4.6 Connection System

Connection System
D-SUB Female and Male Connector Strips, 9 Pin and 25 Pin
Female and Male Connector Strips, Phoenix COMBICON, 3 Pin
RJ45 Female Connector
USB Female Connector A

Technical Data

4.7 Environmental Conditions

Environmental Conditions		
Environmental Temperature	Operation	+ 5 °C to + 45 °C (+ 41 °F to + 113 °F)
	Transportation, Storage	- 20 °C to + 60 °C (- 4 °F to + 140 °F)
Maximum Temperature Gradient	Operation, Transportation, Storage	Temporal Temperature Variations up to 3 K per Minute
Humidity	Operation	Minimum Relative Humidity: 5% Maximum Relative Humidity: 85% Minimum Absolute Humidity: 1 g/m ³ Maximum Absolute Humidity: 25 g/m ³ No Condensation Permitted According to the Clima Class 3K3 to EN 60721-3-3
	Transportation	Minimum Relative Humidity: 5% Maximum Relative Humidity: 75% Minimum Absolute Humidity: 1 g/m ³ Maximum Absolute Humidity: 25 g/m ³ No Condensation Permitted According to the Clima Class 2K2 to EN 60721-3-2
	Storage	Minimum Relative Humidity: 5% Maximum Relative Humidity: 85% Minimum Absolute Humidity: 1 g/m ³ Maximum Absolute Humidity: 25 g/m ³ No Condensation Permitted According to the Clima Class 1K2 to EN 60721-3-1
Atmospheric Pressure	Operation	To 2000 m about Sea Level According to DIN EN 61131-2
	Transportation	To 3000 m about Sea Level According to DIN EN 61131-2
	Storage	To 3000 m about Sea Level According to DIN EN 61131-2
Mechanical Strength	Operation	Maximum Vibration: Frequency Range: 10 Hz to 150 Hz Deflection: 0,075 mm (0.003") at 10 Hz to 57 Hz Acceleration: 1 g at 57 Hz to 150 Hz According to DIN EN 60068-2-6
	Transportation, Storage	Maximum Shock: 15 g 11 ms According to DIN EN 60068-2-27, No Disturbance of the Function
Application Area	Operation	Degree of Pollution 2, Overvoltage Category II
	Transportation, Storage	Degree of Pollution 2

Technical Data

4.8 Applied Standards and Guidelines

Standards and Guidelines	
Interference Immunity	EN 61000-4-2 EN 61000-4-3 EN 61000-4-4 EN 61000-4-5 EN 61000-4-6 EN 61000-6-2
Emitted Interference	EN 55022 Limit Value Class A EN 6100-6-4
Equipment Requirements	EN 61131
Storage and Transportation	EN 61131 Part 2
Power Supply	EN 61131 Part 2
Electromagnetic Compatibility	89/336/EEC (Including all Applicable Amendments)
Degrees of Protection	EN 60529
Impact Load, Shocks	EN 60068 Part 2-27
Sinusoidal Vibrations	EN 60068 Part 2-6
UL/CSA-Certification	UL508 (Industrial Control Equipment) C22.2 No. 14-95 (CSA)



This is a class A device. This device may cause radio interference in residential areas. In this case, the user may be required to introduce appropriate countermeasures, and to bear the cost of same.



You must satisfy the following conditions for a operation in conformity with the UL/CSA:

- Only use isolated copper wires for at least 60/75 °C (140/167 °F)
- Only use isolated wires of class 1.



The UL/CSA identification only applies to the device in the delivery state. After changes at the device e.g. after putting additional expansion boards the UL conformity must be checked.

Technical Data

4.9 Compatibility Test

All Rexroth controls and drives are developed and tested according to the technological state-of-the-art.

As it is impossible to follow the continuing development of all materials (e.g. lubricants in machine tools) which may interact with our controls and drives, it cannot be completely ruled out that any reactions with the materials used by Bosch Rexroth might occur.

For this reason, before using the respective material a compatibility test has to be carried out for new lubricants, cleaning agents etc. and our housings/our housing materials.

Dimensions

5 Dimensions

5.1 Installation



When installing the operating device, keep a minimum clearance of 30 mm (1.181") around the operating device to ensure adequate air circulation.



When the operating device is installed horizontally, please note that additional sources of heat beneath the operating device may result in heat accumulation.

Make sure to allow sufficient heat dissipation!

Comply with the allowable temperature range listed in the technical data for the use of the operating device!



To maintain the specified degree of protection, make sure the seal is evenly seated on the installation surface and the grub screws of the mounting brackets are tightened uniformly.

The operating device can be easily and quickly mounted from the rear of the operating device. This is particularly recommended for mounting in switchboards with a plate thickness of approx. 1 mm to 6 mm (0.039" to 0.236").

1. Insert the operating device from the front through the mounting cut-out.

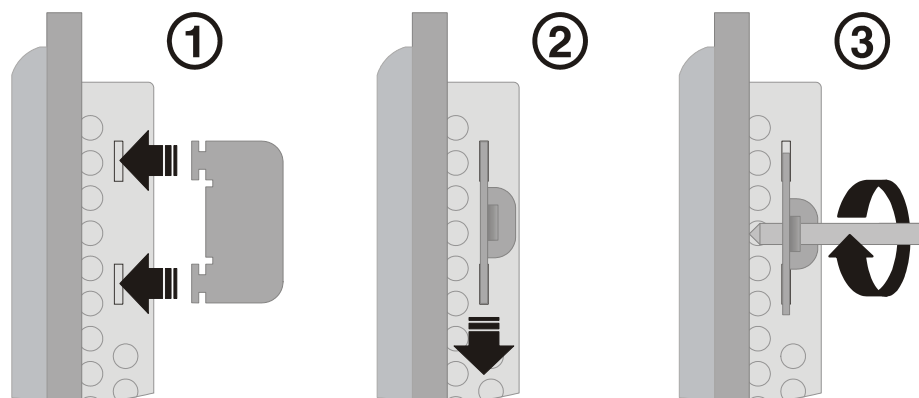

Fig. 5-1: Mounting with mounting brackets

2. Put the assembly brackets into the placket provided for it (point 1) and snap the brackets down into place (point 2).
3. Fasten the operating device with the grub screws (point 3).

Dimensions

5.1.1 Front Panel Dimensions

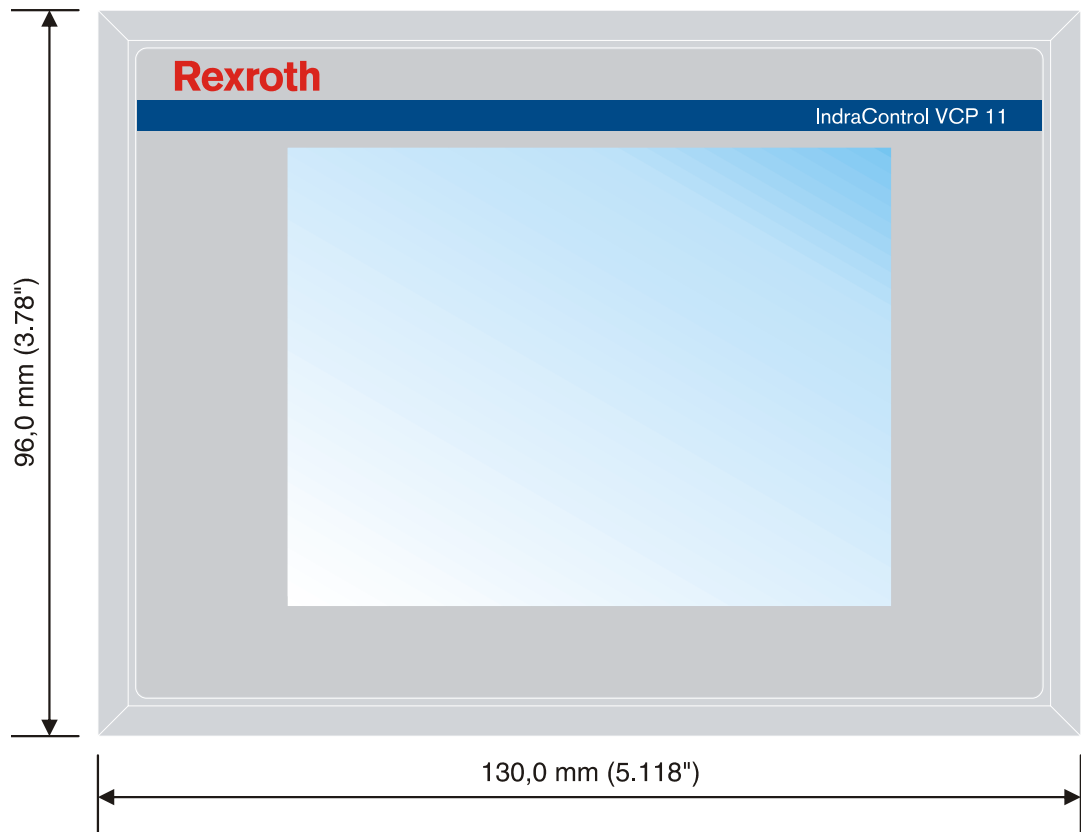

Fig. 5-2: Front panel dimensions

Dimensions

5.1.2 Mounting Cutout

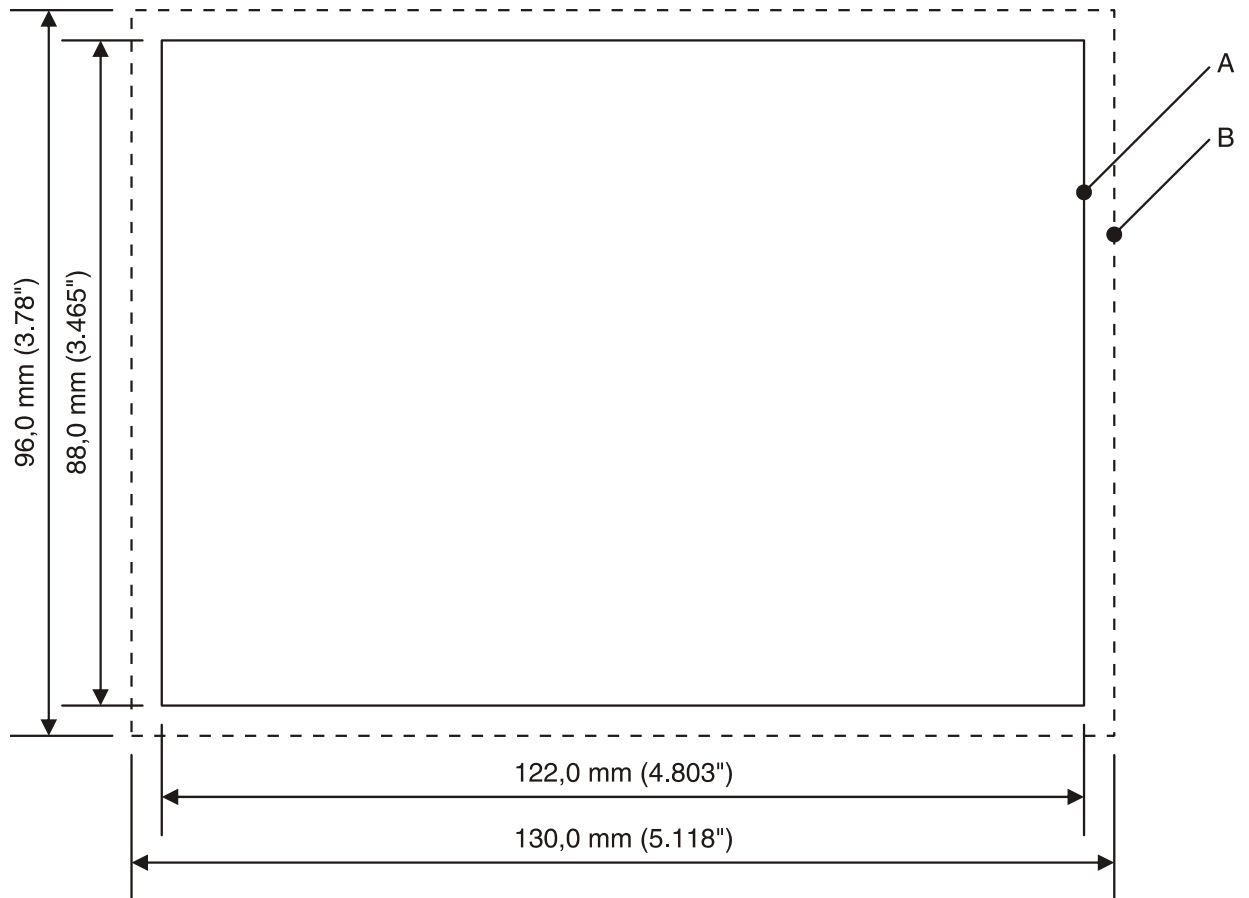

Fig. 5-3: Mounting cutout

- A** Mounting Cutout
- B** Front Panel

Dimensions

5.1.3 Side View with Dimensions

Fig. 5-4: Side view and mounting depth

- 1 Mounting Bracket
- 2 Threaded Pin
- 3 Mounting Surface Thickness 1 mm to 6 mm
- 4 Circumferential Seal
- 5 Front Panel

6 Display and Operating Components

6.1 Display

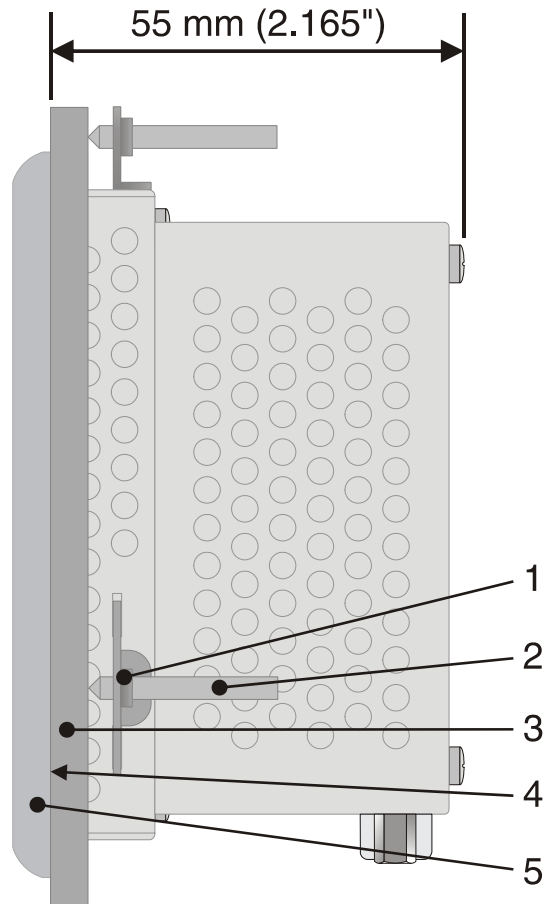

Danger of intoxication!

If the display is damaged, avoid touching, swallowing or breathing in the liquids or gases which may leak out.



Danger of corrosion!

If the display is damaged, avoid touching, swallowing or breathing in the liquids or gases which may leak out.

The small operator terminal is equipped with a FSTN display.

6.1.1 Setting the Contrast

To define the contrast setting, use the programming software to set up the system variable **LcdContrast** in any screen.



To do so, follow the instructions listed in the programming software's help topic "How do I specify the contrast setting for the operating device".

In the programming software, enter the following values as lower and upper limits for the representation type.

System Variable	Lower Limit	Upper Limit	Default Setting
LcdContrast	+ 1	+ 31	+ 15

Fig. 6-1: Values for the representation type



If you do not configure the system variable **LcdContrast**, the default setting is used when the device is initialized.

If you did set-up the system variable, you can set the contrast as follows. Open the screen where you set up the system variable and:

1. Press the brightness button.
2. Enter a new value for the brightness. To do so, use the keyboard shown on the screen.
3. Confirm with Enter.

The new contrast setting becomes effective immediately after the Enter key is pressed. If necessary, repeat the steps two and three until you are satisfied with the contrast.

Display and Operating Components

6.1.2 Character Attributes

The following character attributes can be displayed on the operating device:

- Flashing
- Underline
- Foreground/background color

6.1.3 Fonts

You can use Windows fonts. Windows and unicode character sets are possible.

6.2 Touch Screen

The device is equipped with a resistive 4 wire touch screen. You operate the small operator terminal using this touch screen.



Pointed or sharp objects, such as pens or fingernails, can lead to irreparable damages of the touch screen. Exclusively therefore use the fingertips or the aids indicated in the technical data for the operation.

Interfaces

7 Interfaces

Depending on the device variant, several interfaces are available:

Type Code	Available Interfaces					
	RS232 (X6-SER2)	RS485, RS232c (X6-SER1)	Ethernet (X5)	DeviceNet (X6)	PROFIBUS DP (X6)	USB (X9, X10)
VCPxx.xxxx-xxx-NN-xx-xx	-	-	X	-	-	X
VCPxx.xxxx-xxx-DN-xx-xx	-	-	X	X	-	X
VCPxx.xxxx-xxx-PB-xx-xx	-	-	X	-	X	X
VCPxx.xxxx-xxx-SR-xx-xx	X	X	X	-	-	X

Fig. 7-1: Device Variants

Interfaces

7.1 Standard Interfaces

7.1.1 Ethernet (X5)

A 10/100 Base-T Ethernet interface is located on the side of the operating device.

7.1.1.1 Pin Assignment

Connector in the small operator terminal: RJ45 female connector.

Pin	Designation	Function
1	Tx+	Transmitted Data, Positive Polarity
2	Tx-	Transmitted Data, Negative Polarity
3	Rx+	Received Data, Positive Polarity
4	n.c.	Not connected
5	n.c.	Not Connected
6	Rx-	Received Data, Negative Polarity
7	n.c.	Not Connected
8	n.c.	Not Connected

Fig. 7-2: Pin assignment of the Ethernet interface

7.1.1.2 Cable



A twisted-pair cable of category 6+ (CAT 6+) must be used. The maximum cable length is 100 m (328 feet).



See the IEEE 802.3 standard for further information.

Interfaces

7.1.1.3 Diagnostics

Ethernet diagnostics LEDs are located at the side of the operating device.

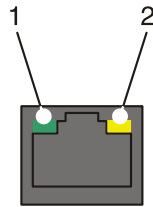

Fig. 7-3: Position of the Ethernet diagnostics LEDs

No.	Color	State	Designation	Function
1	Green	ON	XMT	Sending Ethernet Data Telegram
2	Yellow	ON	RCV	Receiving Ethernet Data Telegram

Fig. 7-4: Function of the Ethernet diagnostics LEDs

7.1.2 USB (X9, X10)

Two host interfaces are available on the operating device.



Using input devices not suitable for industrial use (e.g. keyboard, mouse) may decrease safety of operation. This includes input devices intended for home and office use.

7.1.2.1 Cable



For the specification of a suitable cable, please refer to the „Universal Serial Bus Specification Rev. 2.0“.



The maximum cable length for the cable used is 2.5 m (8.202 feet).

Interfaces

7.2 Serial Interfaces

The universal interface X6 combines several interface standards into one connector. The connector is divided into two channels. The channel for the communication (SER1) is operated separately from the channel for the logging printer/scanner (SER2).

Due to the protocol, only one of the two interface standards can be used for the communication channel (SER1).

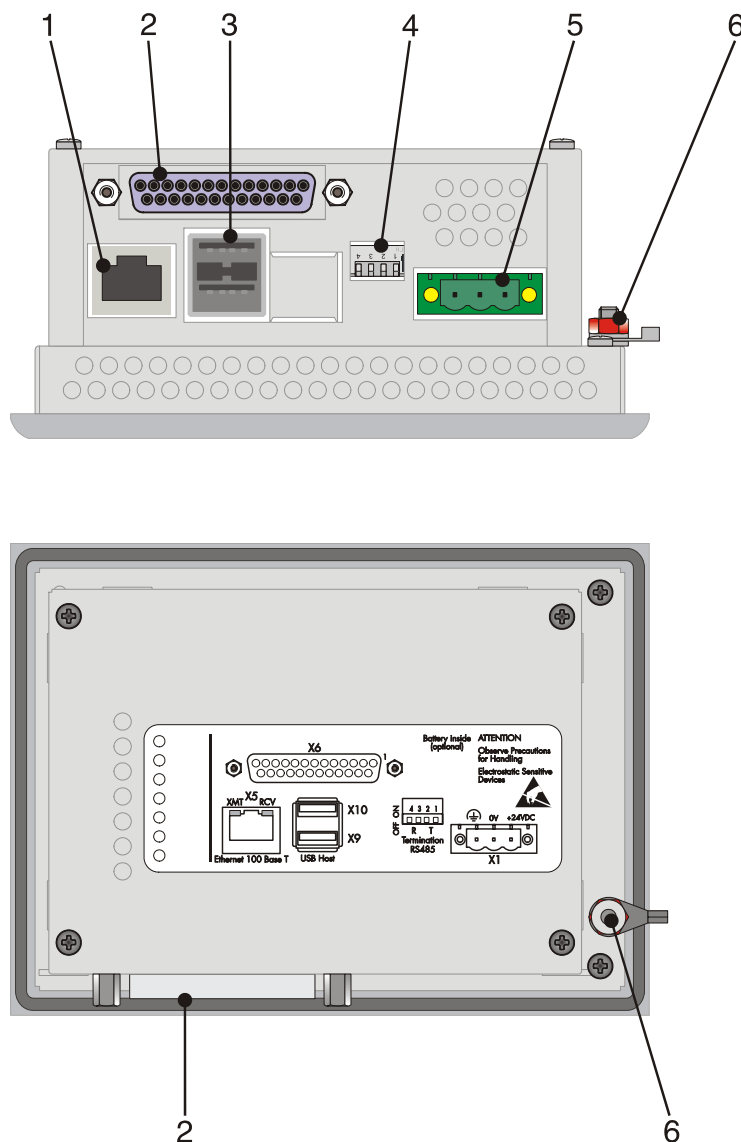

Fig. 7-5: Rear view RS422 / RS485 / RS232

1. Female Connector X5 (Ethernet)
2. Female Connector X6 (RS422/RS485/RS232)
3. Female Connector X9, X10 (USB Host - Type A)
4. Termination Switch (X6-SER1 RS485)
5. Connector X1 (Supply Voltage)
6. Threaded Bolt for Protective Grounding

Interfaces

7.2.1 RS485 (X6-SER1)

The interface is suitable for point-to-point and for multi-point connections.

The wires belonging together are marked with „A“ and „B“. Some descriptions refer to the pins with „+“ and „-“, where A = + and B = -.

Signal Logic 1 $U_A - U_B \leq -0.3 \text{ V}$ i.e. ($U_A < U_B$)

Signal Logic 0 $U_A - U_B \geq +0.3 \text{ V}$ i.e. ($U_A > U_B$)

7.2.1.1 Pin Assignment

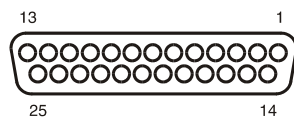

Fig. 7-6: 25 pin D-SUB female connector strip

Connector in the small operator terminal: 25-pin D-SUB female connector strip

Pin	Designation	Function
8	T(A)	Transmitted data (+)
9	T(B)	Transmitted data (-)
11	SGND	Signal Ground
22	R(A)	Received data (+)
23	R(B)	Received data (-)

Fig. 7-7: Pin assignment RS485



The D-SUB connector strips must be shielded sufficiently. See chapter "Shielding D-SUB Connectors" on page 7-15.

7.2.1.2 Termination

For point-to-point connections, always activate the termination. For multi-point connections, only activate the termination at the cable end.

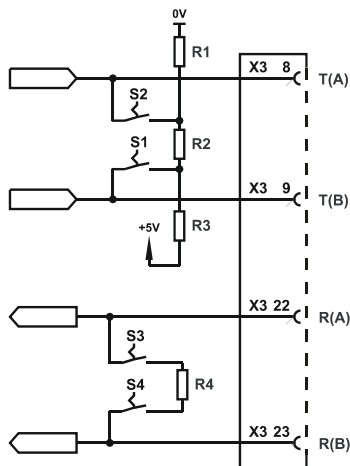

Fig. 7-8: Block diagram termination RS422 / RS485

Designation	Value
R1, R3	510 Ohm
R2	150 Ohm
R4	120 Ohm

Fig. 7-9: Resistance values termination RS422 / RS485



The switch positions for ON or OFF are printed onto the termination switch. Only the specified switch positions are permitted.

S1	S2	S3	S4	Function
Transmitter		Receiver		
				Termination is ON
-	-	-	-	Termination is OFF

Fig. 7-10: Termination switch

Legend for table:

| = Switch ON

- = Switch OFF

Interfaces

7.2.2 RS232 (X6-SER1)

The interface is suitable to establish a point-to-point connection.

7.2.2.1 Pin Assignment

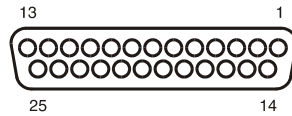

Fig. 7-11: 25 pin D-SUB female connector strip

Connector in the small operator terminal: 25 pin D-SUB female connector strip

Pin	Designation	Function
6	TD	Transmitted Data
15	CTS	Clear to Send
17	RTS	Request to Send
18	RD	Received Data
25	SGND	Signal Ground

Fig. 7-12: Pin assignment RS232



The D-SUB connector strips must be shielded sufficiently. See chapter "Shielding D-SUB Connectors" on page 7-15.

7.2.2.2 Termination



When channel SER1 is operated as a RS232, switch OFF the termination for the RS485.

Interfaces

7.2.3 RS232 (X6-SER2)

As this interface is not galvanically isolated, it should only be used for a scanner or a logging printer.

7.2.3.1 Pin Assignment

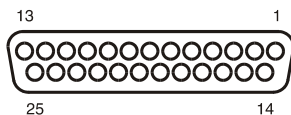

Fig. 7-13: 25 pin D-SUB female connector

Connector in the small operator terminal: 25 pin D-SUB female connector strip

Pin	Designation	Function
1	\oplus	Low-Noise Ground
2	TD	Transmitted Data
3	RD	Received Data
4	RTS	Request to Send
5	CTS	Clear to Send
7	SGND	Signal Ground
20	DTR	Data Transfer Request

Fig. 7-14: Pin assignment of the RS232 interface



The D-SUB connector strips must be shielded sufficiently. See chapter "Shielding D-SUB Connectors" on page 7-15.

Interfaces

7.3 Field Bus Interfaces

7.3.1 DeviceNet Slave (X6)

The device can be integrated into the DeviceNet bus using the interfaces available for DeviceNet connections.

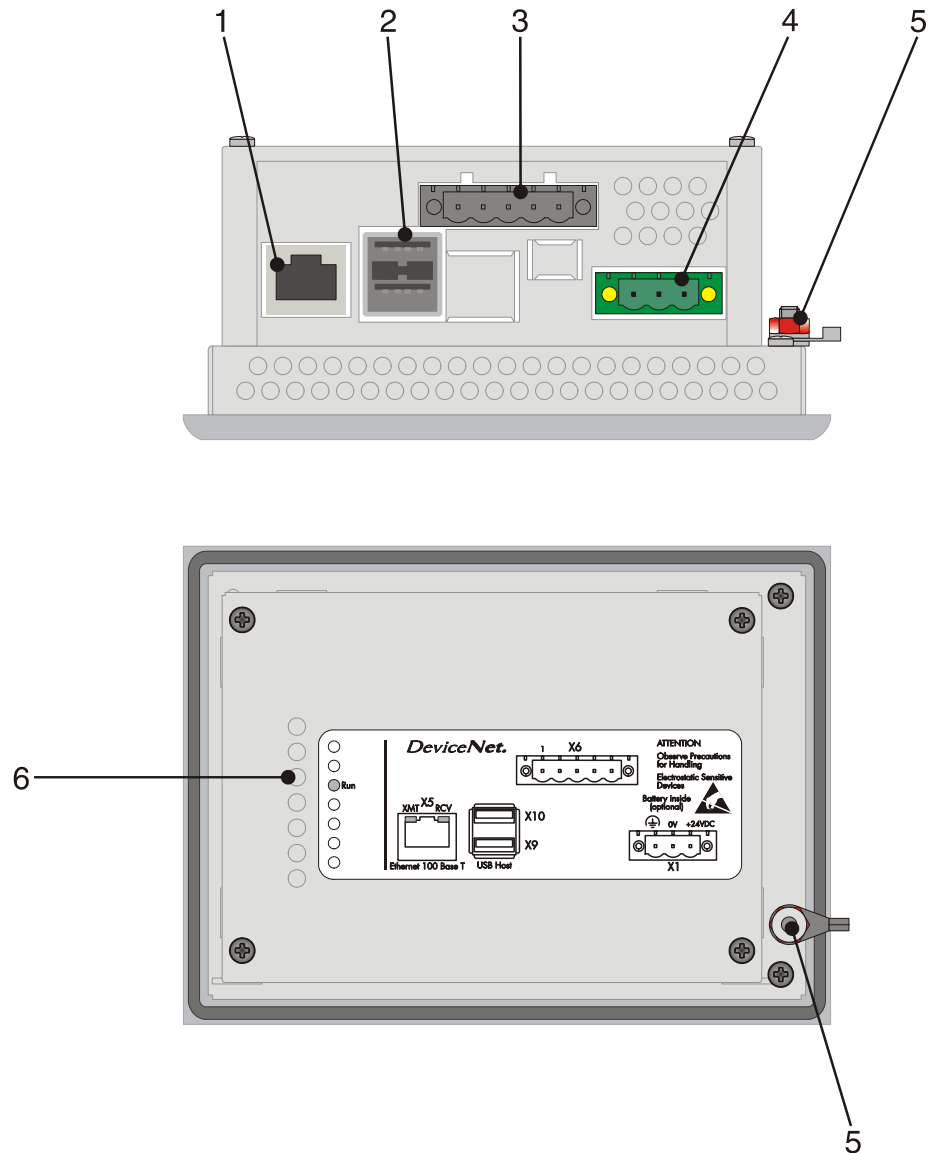

Fig. 7-15: Rear view DeviceNet

1. Female Connector X5 (Ethernet)
2. Female Connectors X9, X10 (USB Host - Type A)
3. Female Connector X6 (DeviceNet)
4. Connector X1 (Supply Voltage)
5. Threaded Bolt for Protective Grounding
6. Diagnostics LED (DeviceNet)

Interfaces

7.3.1.1 Pin Assignment

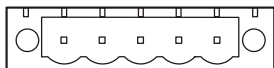

Fig. 7-16: 5 pin connector

Connector in the small operating terminal: 5 pin male connector strip.

Pin	Designation	Function
1	nc	Not Connected
2	CAN_L	CAN_L Bus Line (Dominant LOW)
3	Drain	Shield
4	CAN_H	CAN_H Bus Line (Dominant HIGH)
5	nc	Not Connected

Fig. 7-17: Pin assignment of DeviceNet interface



For the connection, use a 5 pin connector with gold-plated contacts and cover cap.

7.3.1.2 Cable



A DeviceNet-certified cable must be used.

Cable type	Loop resistance	Surge impedance	Capacitance per unit length
2 x 1.1 mm	< 22.6 Ohm/km	120 Ohm	< 39.4 pf/m
2 x 0.6 mm	< 91.8 Ohm/km	120 Ohm	< 39.4 pf/m

Fig. 7-18: Data line DeviceNet

The maximum length allowed for spur lines connected to the bus cable is 6 meters. The overall length of the bus cable including all spur lines is not to exceed the maximum length listed in the table below.

Interfaces

The maximum cable length depends on the baud rate and the cable type used.

Baud rate	Cable type	Cable length
125 kBit/s	2 x 1.1 mm	500 m
	2 x 0.6 mm	100 m
250 kBit/s	2 x 1.1 mm	250 m
	2 x 0.6 mm	100 m
500 kBit/s	2 x 1.1 mm	100 m
	2 x 0.6 mm	100 m

Fig. 7-19: Baud rate DeviceNet

7.3.1.3 Termination

Terminate the CAN bus at both ends by terminating resistors (120 Ohm).

7.3.1.4 Diagnostics

A diagnostics LED is located on the rear of the small operator terminal. The LED shows the states of the bus system.

The diagnostics LED on the small operator terminal has the following functions:

Color	State	Function
Green	OFF	Small operator terminal is disconnected from the bus
Green	ON	Communication Active
Green	Flashing	Sporadic Bus Error

Fig. 7-20: Functions of the DeviceNet diagnostics LED

Interfaces

7.3.2 PROFIBUS DP Slave (X6)

The interface for PROFIBUS DP connections is available to integrate the device into a PROFIBUS DP structure.

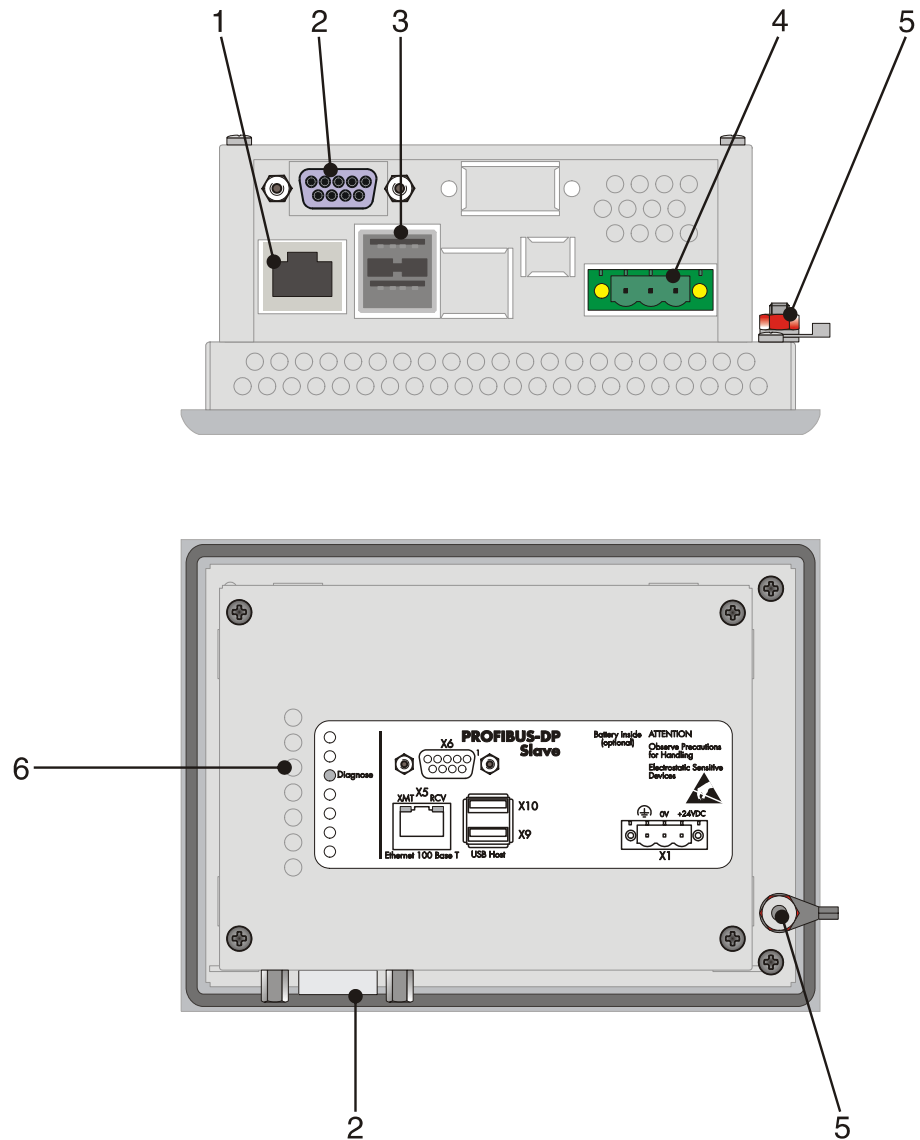

Fig. 7-21: Rear view PROFIBUS DP

1. Female Connector X5 (Ethernet)
2. Female Connector X6 (PROFIBUS)
3. Female Connectors X9, X10 (USB Host - Type A)
4. Connector X1 (Supply Voltage)
5. Threaded Bolt for Protective Grounding
6. Diagnostics LED (PROFIBUS-DP)

Interfaces

7.3.2.1 Pin Assignment

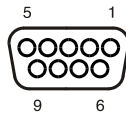

Fig. 7-22: 9-pin D-SUB female connector strip

Connector in the small operator terminal: 9-pin D-SUB female connector strip

Pin	Designation	Function
1	nc	Not Connected
2	nc	Not Connected
3	RxD/TxD-P	Received Data / Transmitted Data Plus
4	CNTR-P	Repeater Control Signal Plus
5	DGND	Data Transmission Potential
6	VP	Supply Voltage of Terminators Plus
7	nc	Not Connected
8	RxD/TxD-N	Received Data / Transmitted Data Minus
9	CNTR-N	Repeater Control Signal Minus

Fig. 7-23: Pin assignment PROFIBUS DP



The D-SUB connector strips must be shielded sufficiently. See chapter "Shielding D-SUB Connectors" on page 7-15.

7.3.2.2 Cable



Any PROFIBUS DP-approved cables specified in the EN 50170 as cable type A can be used.

Parameter	Value
Wave Impedance	136 to 165 Ohm
Capacitance Per Unit Length	< 30 pf/m
Loop Impedance	110 Ohm/km
Wire Diameter	0.64 mm (0.002")

Fig. 7-24: Cable characteristics PROFIBUS

Interfaces

The maximum line length depends on the baud rate used (DIN EN 19245 Part 3).

Baud Rate	Cable Length
187.5 kBit/s	1000 m (3280.839 feet)
500 kBit/s	400 m (1312.335 feet)
1500 kBit/s	200 m (656.167 feet)
3000 to 12000 kBit/s	100 m (328.083 feet)

Fig. 7-25: Baud rate PROFIBUS

7.3.2.3 Termination

Terminate the PROFIBUS at both ends by terminating resistors. If you are using special PROFIBUS connectors, these resistors are usually integrated into the connector and can be connected.

7.3.2.4 Diagnostics

A diagnostics LED is located on the rear of the small operator terminal. The LED shows the states of the bus system.

The diagnostics LED on the small operator terminal has the following function:

Color	State	Function
Green	ON	Communication Active

Fig. 7-26: Function of the PROFIBUS-DP diagnostics LED

Interfaces

7.4 Shielding D-SUB Connectors

You must shield D-SUB connectors as follows:

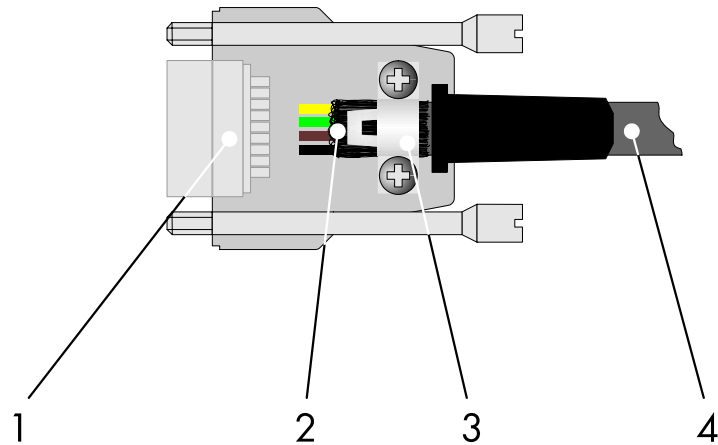

Fig. 7-27: Shielding D-SUB connectors

- 1 D-SUB connector
- 2 Shield
- 3 Cable clip
- 4 Cable

The shield must be folded back into a flat position over the cable sheath.

When fastening the cable with the cable clip, as much of the shielding as possible must be in contact with the housing and sufficient strain relieve must be ensured.

Interfaces

8 Maintenance and Installation

8.1 General Information

VCP-type operator terminals are maintenance-free. A few parts are subject to wear and must be replaced after a certain number of operating hours.

8.2 Exchange of Hardware Components

**CAUTION**

Maintenance work in the device is only permissible by skilled staff!

If hardware components have to be exchanged, please contact the Bosch Rexroth Service or ensure that only skilled staff changes the respective components.

8.3 Data Backup

**CAUTION**

The Bosch Rexroth AG is not liable for possible data loss and the damages resulting from this!

The customer himself is responsible for the backup of customer-specific data and must provide this data in case of service.

8.4 Unpacking the Device

Unpack all parts carefully and check the contents for any visible damage in transit. Also check whether the shipment matches the specifications on your delivery note.

If you notice damages in transit or discrepancies, please contact our sales department immediately.

8.5 Identification

You can identify the small operator terminal by the nameplate on the rear.

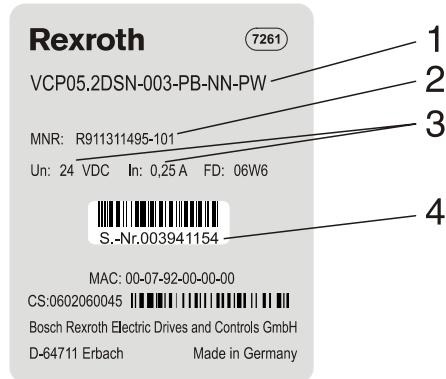

Fig. 8-1: Nameplate (example)

- 1 Ordering name / Short type designation
- 2 Part number
- 3 Voltage and power specification
- 4 Serial number

8.6 Connecting the Device

8.6.1 Supply Voltage 24 V

The supply voltage is supplied via connector X1.

The device has reverse polarity protection. In case of wrong polarity, the device will not operate.

This is a protection class I device. For safe operation, safety extra-low voltage (SELV) in accordance with DIN EN 61131 must be used for the supply voltage.

Connector in the small operator terminal: 3-pin connector Phoenix COMBICON MSTBV 2,5/3-GF.

Pin	Designation	Function
1		Low-Noise Ground
2	0 V	Supply Voltage 0 V
3	24 VDC	Supply Voltage 24 VDC

Fig. 8-2: Pin assignment supply voltage

A suitable female connector strip of the type Phoenix COMBICON MSTB 2,5/3-STF is supplied.



A cable with finely stranded wires with a minimum cross-section of 0.75 mm² (18 AWG) and a maximum cross-section of 2.5 mm² (14 AWG) must be used for the supply voltage.



WARNING

Hazardous voltages can exist inside electrical installations that can pose a danger to humans. Coming in contact with live parts may result in electric shock!

Maintenance and Installation

Use the following procedure to connect the device to the supply voltage:

1. Remove approx. 30 mm (1.181") off the outer cable sheath and approx. 5 mm (0.197") off the wires.

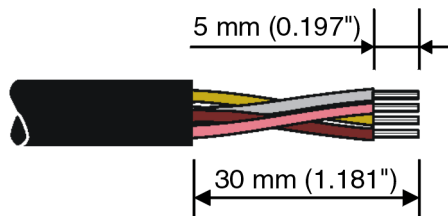

Fig. 8-3: Preparing the cable

2. Fit the wires with wire end ferrules and connect the wires to the connector.

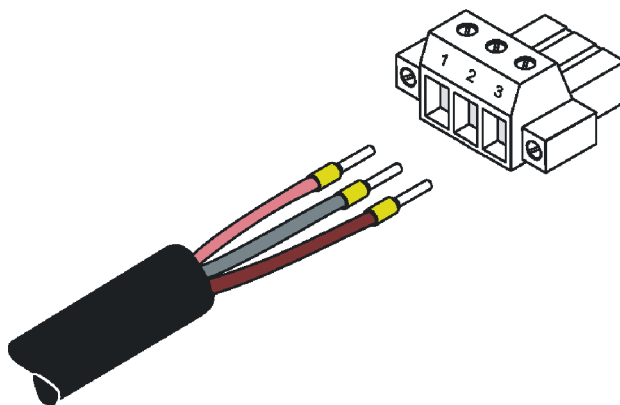

Fig. 8-4: Connecting the female connector strip



If shielded connecting cables are used in the supply voltage area, the shield should be connected to pin 1.

Maintenance and Installation

3. Plug the female connector strip onto connector X1.

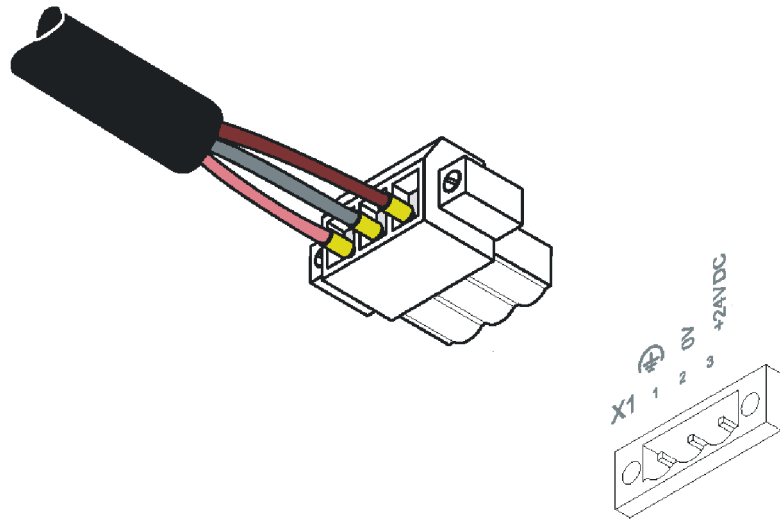

Fig. 8-5: Female connector strip is plugged on

4. Secure the female connector strip in place with a screw-type locking to prevent it from slipping out.



A separate conductor must always be provided for the protective grounding at the threaded bolt. The conductor must have a minimum cross-section of 1.5 mm² (16 AWG) and must be kept as short as possible.

8.7 Front Panel

Only use a damp cloth to remove any dirt from the front panel.

8.8 Fuse



The semiconductor fuse cannot be replaced!

A semiconductor fuse is used to protect the device. Once the fuse has been tripped, the device must be disconnected from the supply voltage to allow the semiconductor fuse to regenerate. At an ambient temperature of 20 °C (68° F), the regeneration takes approximately 20 seconds. The higher the ambient temperature, the longer the regeneration takes.

8.9 Battery

The built-in battery preserves the data in the SRAM and supplies the real-time clock with power. The minimum battery life is 5 years, even under unfavorable operating conditions. When the battery runs down, the message "Change battery" is generated automatically.

We recommend you change the battery approximately every 4 years as part of the regular maintenance work. A pre-assembled battery including connector can be obtained directly from Bosch Rexroth (order designation: VAS04.1-001-002-NN, MN: R911316662).

If the "Change battery" message is detected too late, data in the SRAM may have already been lost. For this reason, after changing a battery, always check data such as editable passwords, parameters in the system variables, data sets of the recipes and entries in the message system.

8.9.1 Changing the Battery

To ensure that the data in the SRAM and the time are preserved, it is possible to change the battery under operating voltage. Observe the corresponding safety notices!

1. Remove the screws on the rear panel of the device and lift off the enclosure cover.
2. Remove the adhesive tape securing the battery.
3. Disconnect the connector from the battery and remove the dead battery.
4. Plug in the cable for the new battery.
5. Use the included adhesive tape to attach the new battery to the enclosure.
6. Place the enclosure cover back onto the device.
7. Carefully tighten the screws of the enclosure cover.

8.9.2 Battery Disposal



To prevent short circuitry in the collection boxes, insulate the poles of each battery with insulation tape or put each single battery into a plastic bag.

You must always return old batteries to a dealer or to a returns depot set up for this purpose by the public waste disposal body or a licensed battery dealer for recycling. Only dispose of dead batteries in public or commercial collection boxes. The battery is drained when the message „Change battery“ appears on the display of the device.

Ordering Information

9.2 Accessories



Order Designation prep. Cable	Complementary Con- nector of Device	Rexroth Cable	Cable End Design
IKB0051/000,0 MN: R911305089 Serial Cable RS422 to PPC-R	INS0645/K01 		INS0520/L01 
IKB0052/000,0 MN:R911305090 Serial Cable RS232 to PPC-R	INS0760/C01 		INS0520/L01 
IKB0053/003,0 MN:R911305271 Serial Cable from PC to VCP for Loop-through Operation			
RKB0002/000,0 MN: R911307610 Serial Cable RS232 to IndraControl L40	INS0526/L01 		INS0520/L01 
RKB0004/002,0 MN: R911309311 RKB0004/005,0 MN: R911309098 RKB0004/010,0 MN: R911309312 Serial Cable RS232 to IndraDrive			INS0769/L01 
IKB0033/000,0 MN: R911291808 PROFIBUS Cable	INS0541/K01 		INS0541/K01 

Fig. 9-2: Accessories

Ordering Information

9.2.1 Ethernet Cable

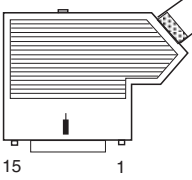
Order Designation	Material Number	Description
RKB0007/002,5..(*****_*****_*****)	R911170147	Ethernet Cable, 10-Base-T, CAT.6+, Crosslink, UL, Pre-assembled on Both Sides with RJ45 Connector, 2.5 m (8.2 ft.)
RKB0007/005,0..(*****_*****_*****)	R911170148	Ethernet Cable, 10-Base-T, CAT.6+, Crosslink, UL, Pre-assembled on Both Sides with RJ45 Connector, 5 m (16.4 ft.)
RKB0007/010,0..(*****_*****_*****)	R911170149	Ethernet Cable, 10-Base-T, CAT.6+, Crosslink, UL, Pre-assembled on Both Sides with RJ45 Connector, 10 m (32.8 ft.)
RKB0007/025,0..(*****_*****_*****)	R911170150	Ethernet Cable, 10-Base-T, CAT.6+, Crosslink, UL, Pre-assembled on Both Sides with RJ45 Connector, 25 m (82 ft.)
RKB0008/002,5..(*****_*****_*****)	R911170151	Ethernet Cable, 10-Base-T, CAT.6+, UL, Pre-assembled on Both Sides with RJ45 Connector, 2.5 m (8.2 ft.)
RKB0008/005,0..(*****_*****_*****)	R911170152	Ethernet Cable, 10-Base-T, CAT.6+, UL, Pre-assembled on Both Sides with RJ45 Connector, 5 m (16.4 ft.)
RKB0008/010,0..(*****_*****_*****)	R911170153	Ethernet Cable, 10-Base-T, CAT.6+, UL, Pre-assembled on Both Sides with RJ45 Connector, 10 m (32.8 ft.)
RKB0008/025,0..(*****_*****_*****)	R911170154	Ethernet Cable, 10-Base-T, CAT.6+, UL, Pre-assembled on Both Sides with RJ45 Connector, 25 m (82 ft.)

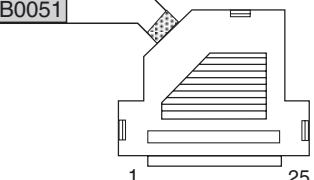
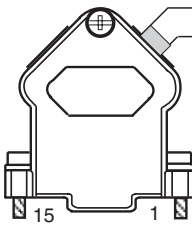
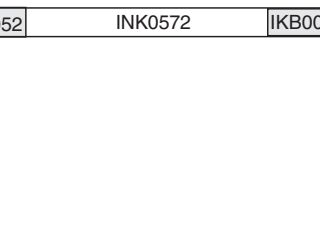
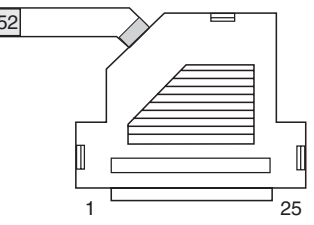
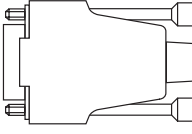
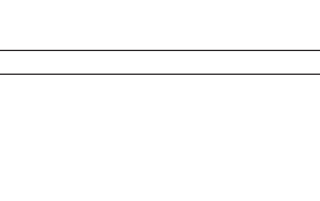
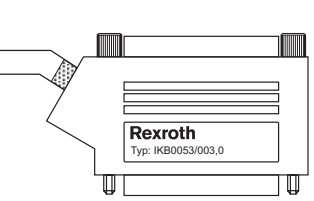
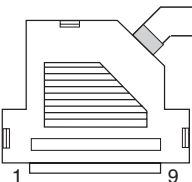
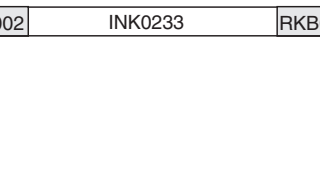
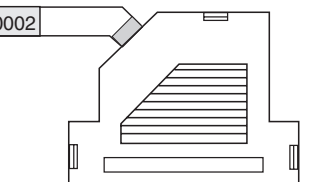
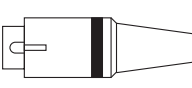
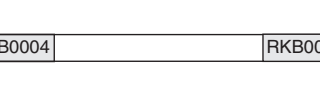
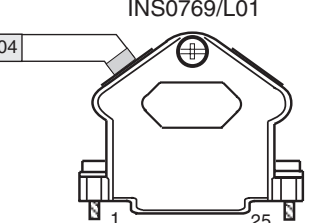
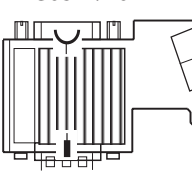
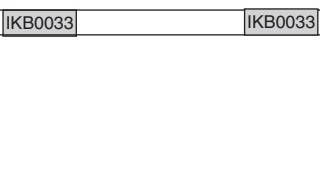
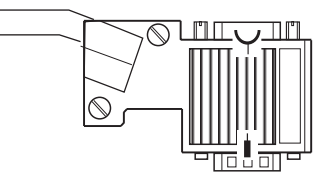
Fig. 9-3: Order Designation Ethernet Cable

Ordering Information

Disposal and Environmental Protection

10 Disposal and Environmental Protection

10.1 Disposal

10.1.1 Products

Our products can be returned to us free of charge for disposal. It is a precondition, however, that the products are free of oil, grease or other dirt.

Furthermore, the products returned for disposal must not contain any undue foreign matter or foreign component.

Please send the products free domicile to the following address:

Bosch Rexroth AG
Electric Drives and Controls
Bürgermeister-Dr.-Nebel-Straße 2
D-97816 Lohr am Main

10.1.2 Packaging Materials

The packaging materials consist of cardboard, wood and polystyrene. These materials can be easily recycled. For ecological reasons, please refrain from returning the empty packages to us.

10.2 Environmental Protection

10.2.1 No Release of Hazardous Substances

Our products do not contain any hazardous substances, which may be released in the case of appropriate use. Accordingly, our products will normally not have any negative effect on the environment.

10.2.2 Materials Contained in the Products

10.2.2.1 Electronic Devices

Electronic devices mainly contain:

- steel
- aluminium
- copper
- synthetic materials
- electronic components and modules

Disposal and Environmental Protection

10.2.2.2 Motors

Motors mainly contain:

- steel
- aluminium
- copper
- brass
- magnetic materials
- electronic components and modules

10.2.3 Recycling

Due to their high content of metal most of the product components can be recycled. In order to recycle the metal in the best possible way, the products must be disassembled into individual modules.

Metals contained in electric and electronic modules can also be recycled by means of special separation processes. The synthetic materials remaining after these processes can be thermally recycled.

If the products contain batteries or rechargeable batteries, these batteries are to be removed and disposed before they are recycled.

11 List of Figures

- Fig. 1-1: VCP 11 with touch screen 1-1
- Fig. 3-1: Hazard classification (according to ANSI Z535) 3-1
- Fig. 5-1: Mounting with mounting brackets 5-1
- Fig. 5-2: Front panel dimensions 5-2
- Fig. 5-3: Mounting cutout 5-3
- Fig. 5-4: Side view and mounting depth 5-4
- Fig. 6-1: Values for the representation type 6-1
- Fig. 7-1: Device Variants 7-1
- Fig. 7-2: Pin assignment of the Ethernet interface 7-2
- Fig. 7-3: Position of the Ethernet diagnostics LEDs 7-3
- Fig. 7-4: Function of the Ethernet diagnostics LEDs 7-3
- Fig. 7-5: Rear view RS422 / RS485 / RS232 7-4
- Fig. 7-6: 25 pin D-SUB female connector strip 7-5
- Fig. 7-7: Pin assignment RS485 7-5
- Fig. 7-8: Block diagram termination RS422 / RS485 7-6
- Fig. 7-9: Resistance values termination RS422 / RS485 7-6
- Fig. 7-10: Termination switch 7-6
- Fig. 7-11: 25 pin D-SUB female connector strip 7-7
- Fig. 7-12: Pin assignment RS232 7-7
- Fig. 7-13: 25 pin D-SUB female connector 7-8
- Fig. 7-14: Pin assignment of the RS232 interface 7-8
- Fig. 7-15: Rear view DeviceNet 7-9
- Fig. 7-16: 5 pin connector 7-10
- Fig. 7-17: Pin assignment of DeviceNet interface 7-10
- Fig. 7-18: Data line DeviceNet 7-10
- Fig. 7-19: Baud rate DeviceNet 7-11
- Fig. 7-20: Functions of the DeviceNet diagnostics LED 7-11
- Fig. 7-21: Rear view PROFIBUS DP 7-12
- Fig. 7-22: 9-pin D-SUB female connector strip 7-13
- Fig. 7-23: Pin assignment PROFIBUS DP 7-13
- Fig. 7-24: Cable characteristics PROFIBUS 7-13
- Fig. 7-25: Baud rate PROFIBUS 7-14
- Fig. 7-26: Function of the PROFIBUS-DP diagnostics LED 7-14
- Fig. 7-27: Shielding D-SUB connectors 7-15
- Fig. 8-1: Nameplate (example) 8-2
- Fig. 8-2: Pin assignment supply voltage 8-3
- Fig. 8-3: Preparing the cable 8-4
- Fig. 8-4: Connecting the female connector strip 8-4
- Fig. 8-5: Female connector strip is plugged on 8-5
- Fig. 9-1: Type code 9-1
- Fig. 9-2: Accessories 9-2
- Fig. 9-3: Order Designation Ethernet Cable 9-3

List of Figures

Index

12 Index

B

Battery 8-6
Battery disposal 8-6

C

Cable
 DeviceNet 7-10
 Ethernet 7-2
 PROFIBUS DP 7-13
 USB 7-3
Changing the battery 8-6
Character attributes 6-2
Compatibility test 4-6
Connecting 8-3

D

Device variants 7-1
Diagnostics
 DeviceNet 7-11
 Ethernet 7-3
 PROFIBUS DP 7-14
Dimensions
 Cutout 5-3
 Front panel 5-2
 Side view 5-4

F

Font
 Windows 6-2
Fuse 8-5

I

Identification 8-2
Interface
 DeviceNet slave 7-9
 Ethernet 7-2
 PROFIBUS slave 7-12
 RS232 7-7, 7-8
 RS485 7-5
 USB 7-3

L

LcdContrast 6-1

N

Nameplate 8-2

P

Pin assignment
 DeviceNet 7-10
 Ethernet 7-2
 PROFIBUS DP 7-13

Index

RS232 7-7, 7-8
RS422 7-5
RS485 7-5

S

Setting the contrast 6-1
Standards 4-5
Supply voltage 24 V 8-3

T

Technical data 4-1
Termination
 DeviceNet 7-11
 PROFIBUS DP 7-14
 RS232 7-7
 RS422 7-6
 RS485 7-6
Termination switch 7-6
Touch screen 6-2

U

Unpacking 8-1

Service & Support

13 Service & Support

13.1 Helpdesk

Unser Kundendienst-Helpdesk im Hauptwerk Lohr am Main steht Ihnen mit Rat und Tat zur Seite. Sie erreichen uns

Our service helpdesk at our headquarters in Lohr am Main, Germany can assist you in all kinds of inquiries. Contact us

- telefonisch - by phone:
über Service Call Entry Center
- via Service Call Entry Center
- per Fax - by fax:
- per e-Mail - by e-mail: service.svc@boschrexroth.de

49 (0) 9352 40 50 60

Mo-Fr 07:00-18:00
Mo-Fr 7:00 am - 6:00 pm

+49 (0) 9352 40 49 41

13.2 Service-Hotline

Außerhalb der Helpdesk-Zeiten ist der Service direkt ansprechbar unter

After helpdesk hours, contact our service department directly at

+49 (0) 171 333 88 26

oder - or

+49 (0) 172 660 04 06

13.3 Internet

Unter www.boschrexroth.com finden Sie ergänzende Hinweise zu Service, Reparatur und Training sowie die **aktuellen** Adressen *) unserer auf den folgenden Seiten aufgeführten Vertriebs- und Servicebüros.



Verkaufsniederlassungen



Niederlassungen mit Kundendienst

Außerhalb Deutschlands nehmen Sie bitte zuerst Kontakt mit unserem für Sie nächstgelegenen Ansprechpartner auf.

*) Die Angaben in der vorliegenden Dokumentation können seit Drucklegung überholt sein.

At www.boschrexroth.com you may find additional notes about service, repairs and training in the Internet, as well as the **actual** addresses *) of our sales- and service facilities figuring on the following pages.



sales agencies



offices providing service

Please contact our sales / service office in your area first.

*) Data in the present documentation may have become obsolete since printing.

Service & Support

13.4 Vor der Kontaktaufnahme... - Before contacting us...

Wir können Ihnen schnell und effizient helfen wenn Sie folgende Informationen bereithalten:

1. detaillierte Beschreibung der Störung und der Umstände.
2. Angaben auf dem Typenschild der betreffenden Produkte, insbesondere Typenschlüssel und Seriennummern.
3. Tel./Faxnummern und e-Mail-Adresse, unter denen Sie für Rückfragen zu erreichen sind.

For quick and efficient help, please have the following information ready:

1. Detailed description of the failure and circumstances.
2. Information on the type plate of the affected products, especially type codes and serial numbers.
3. Your phone/fax numbers and email address, so we can contact you in case of questions.

13.5 Kundenbetreuungsstellen - Sales & Service Facilities

13.5.1 Deutschland - Germany

vom Ausland:
from abroad:

(0) nach Landeskenziffer weglassen!
don't dial (0) after country code!

Vertriebsgebiet Mitte Germany Centre Rexroth Indramat GmbH Bgm.-Dr.-Nebel-Str. 2 / Postf. 1357 97816 Lohr am Main / 97803 Lohr Kompetenz-Zentrum Europa Tel.: +49 (0)9352 40-0 Fax: +49 (0)9352 40-4885	SERVICE CALL ENTRY CENTER MO – FR von 07:00 - 18:00 Uhr from 7 am – 6 pm Tel. +49 (0) 9352 40 50 60 service.svc@boschrexroth.de	SERVICE HOTLINE MO – FR von 17:00 - 07:00 Uhr from 5 pm - 7 am + SA / SO Tel.: +49 (0)172 660 04 06 oder / or Tel.: +49 (0)171 333 88 26	SERVICE ERSATZTEILE / SPARES verlängerte Ansprechzeit - extended office time - ♦ nur an Werktagen - only on working days - ♦ von 07:00 - 18:00 Uhr - from 7 am - 6 pm - Tel. +49 (0) 9352 40 42 22
Vertriebsgebiet Süd Germany South Bosch Rexroth AG Landshuter Allee 8-10 80637 München Tel.: +49 (0)89 127 14-0 Fax: +49 (0)89 127 14-490	Vertriebsgebiet West Germany West Bosch Rexroth AG Regionalzentrum West Borsigstrasse 15 40880 Ratingen Tel.: +49 (0)2102 409-0 Fax: +49 (0)2102 409-406 +49 (0)2102 409-430	Gebiet Südwest Germany South-West Bosch Rexroth AG Service-Regionalzentrum Süd-West Siemensstr.1 70736 Fellbach Tel.: +49 (0)711 51046-0 Fax: +49 (0)711 51046-248	
Vertriebsgebiet Nord Germany North Bosch Rexroth AG Walsroder Str. 93 30853 Langenhagen Tel.: +49 (0) 511 72 66 57-0 Service: +49 (0) 511 72 66 57-256 Fax: +49 (0) 511 72 66 57-93 Service: +49 (0) 511 72 66 57-783	Vertriebsgebiet Mitte Germany Centre Bosch Rexroth AG Regionalzentrum Mitte Waldecker Straße 13 64546 Mörfelden-Walldorf Tel.: +49 (0) 61 05 702-3 Fax: +49 (0) 61 05 702-444	Vertriebsgebiet Ost Germany East Bosch Rexroth AG Beckerstraße 31 09120 Chemnitz Tel.: +49 (0)371 35 55-0 Fax: +49 (0)371 35 55-333	Vertriebsgebiet Ost Germany East Bosch Rexroth AG Regionalzentrum Ost Walter-Köhn-Str. 4d 04356 Leipzig Tel.: +49 (0)341 25 61-0 Fax: +49 (0)341 25 61-111

Service & Support

13.5.2 Europa (West) - Europe (West)

vom Ausland: (0) nach Landeskenziffer weglassen, **Italien:** 0 nach Landeskenziffer mitwählen
from abroad: don't dial (0) after country code, **Italy:** dial 0 after country code

<p>Austria - Österreich</p> <p>Bosch Rexroth GmbH Electric Drives & Controls Stachegasse 13 1120 Wien</p> <p>Tel.: +43 (0)1 985 25 40 Fax: +43 (0)1 985 25 40-93</p>	<p>Austria – Österreich</p> <p>Bosch Rexroth GmbH Electric Drives & Controls Industriepark 18 4061 Pasching</p> <p>Tel.: +43 (0)7221 605-0 Fax: +43 (0)7221 605-21</p>	<p>Belgium - Belgien</p> <p>Bosch Rexroth NV/SA Henri Genessestraat 1 1070 Bruxelles</p> <p>Tel: +32 (0) 2 582 31 80 Fax: +32 (0) 2 582 43 10 info@boschrexroth.be service@boschrexroth.be</p>	<p>Denmark - Dänemark</p> <p>BEC A/S Zinkvej 6 8900 Randers</p> <p>Tel.: +45 (0)87 11 90 60 Fax: +45 (0)87 11 90 61</p>
<p>Great Britain – Großbritannien</p> <p>Bosch Rexroth Ltd. Electric Drives & Controls Broadway Lane, South Cerney Cirencester, Glos GL7 5UH</p> <p>Tel.: +44 (0)1285 863000 Fax: +44 (0)1285 863030 sales@boschrexroth.co.uk service@boschrexroth.co.uk</p>	<p>Finland - Finnland</p> <p>Bosch Rexroth Oy Electric Drives & Controls Ansatie 6 017 40 Vantaa</p> <p>Tel.: +358 (0)9 84 91-11 Fax: +358 (0)9 84 91-13 60</p>	<p>France - Frankreich</p> <p>Bosch Rexroth SAS Electric Drives & Controls Avenue de la Trentaine (BP. 74) 77503 Chelles Cedex</p> <p>Tel.: +33 (0)164 72-70 00 Fax: +33 (0)164 72-63 00 Hotline: +33 (0)608 33 43 28</p>	<p>France - Frankreich</p> <p>Bosch Rexroth SAS Electric Drives & Controls ZI de Thibaud, 20 bd. Thibaud (BP. 1751) 31084 Toulouse</p> <p>Tel.: +33 (0)5 61 43 61 87 Fax: +33 (0)5 61 43 94 12</p>
<p>France – Frankreich</p> <p>Bosch Rexroth SAS Electric Drives & Controls 91, Bd. Irène Joliot-Curie 69634 Vénissieux – Cedex</p> <p>Tel.: +33 (0)4 78 78 53 65 Fax: +33 (0)4 78 78 53 62</p>	<p>Italy - Italien</p> <p>Bosch Rexroth S.p.A. Via G. Di Vittorio, 1 20063 Cernusco S/N.MI</p> <p>Hotline: +39 02 92 365 563 Tel.: +39 02 92 365 1 Service: +39 02 92 365 326 Fax: +39 02 92 365 500 Service: +39 02 92 365 503</p>	<p>Italy - Italien</p> <p>Bosch Rexroth S.p.A. Via Paolo Veronesi, 250 10148 Torino</p> <p>Tel.: +39 011 224 88 11 Fax: +39 011 224 88 30</p>	<p>Italy - Italien</p> <p>Bosch Rexroth S.p.A. Via Mascia, 1 80053 Castellammare di Stabia NA</p> <p>Tel.: +39 081 8 71 57 00 Fax: +39 081 8 71 68 85</p>
<p>Italy - Italien</p> <p>Bosch Rexroth S.p.A. Via del Progresso, 16 (Zona Ind.) 35020 Padova</p> <p>Tel.: +39 049 8 70 13 70 Fax: +39 049 8 70 13 77</p>	<p>Italy - Italien</p> <p>Bosch Rexroth S.p.A. Via Isonzo, 61 40033 Casalecchio di Reno (Bo)</p> <p>Tel.: +39 051 29 86 430 Fax: +39 051 29 86 490</p>	<p>Netherlands - Niederlande/Holland</p> <p>Bosch Rexroth Services B.V. Technical Services Kruisbroeksestraat 1 (P.O. Box 32) 5281 RV Boxtel</p> <p>Tel.: +31 (0) 411 65 16 40 +31 (0) 411 65 17 27 Fax: +31 (0) 411 67 78 14 +31 (0) 411 68 28 60 services@boschrexroth.nl</p>	<p>Netherlands – Niederlande/Holland</p> <p>Bosch Rexroth B.V. Kruisbroeksestraat 1 (P.O. Box 32) 5281 RV Boxtel</p> <p>Tel.: +31 (0) 411 65 19 51 Fax: +31 (0) 411 65 14 83 www.boschrexroth.nl</p>
<p>Norway - Norwegen</p> <p>Bosch Rexroth AS Electric Drives & Controls Berghagan 1 or: Box 3007 1405 Ski-Langhus 1402 Ski</p> <p>Tel.: +47 (0) 64 86 41 00 Fax: +47 (0) 64 86 90 62</p> <p>Hotline: +47 (0)64 86 94 82 jul.ruud@rexroth.no</p>	<p>Spain - Spanien</p> <p>Bosch Rexroth S.A. Electric Drives & Controls Centro Industrial Santiga Obradors s/n 08130 Santa Perpetua de Mogoda Barcelona</p> <p>Tel.: +34 9 37 47 94 00 Fax: +34 9 37 47 94 01</p>	<p>Spain – Spanien</p> <p>Goimendi S.A. Electric Drives & Controls Parque Empresarial Zuatzu C/ Francisco Grandmontagne no.2 20018 San Sebastian</p> <p>Tel.: +34 9 43 31 84 21 - service: +34 9 43 31 84 56 Fax: +34 9 43 31 84 27 - service: +34 9 43 31 84 60 sat.indramat@goimendi.es</p>	<p>Sweden - Schweden</p> <p>Bosch Rexroth AB Electric Drives & Controls Ekvåndan 7 254 67 Helsingborg</p> <p>Tel.: +46 (0) 42 38 88 -50 Fax: +46 (0) 42 38 88 -74</p>
<p>Sweden - Schweden</p> <p>Bosch Rexroth AB Electric Drives & Controls Ekvåndan 7 254 67 Helsingborg</p> <p>Tel.: +46 (0) 42 38 88 -50 Fax: +46 (0) 42 38 88 -74</p>	<p>Switzerland East - Schweiz Ost</p> <p>Bosch Rexroth Schweiz AG Electric Drives & Controls Hemrietstrasse 2 8863 Buttikon</p> <p>Tel. +41 (0) 55 46 46 111 Fax +41 (0) 55 46 46 222</p>	<p>Switzerland West - Schweiz West</p> <p>Bosch Rexroth Suisse SA Av. Général Guisan 26 1800 Vevey 1</p> <p>Tel.: +41 (0)21 632 84 20 Fax: +41 (0)21 632 84 21</p>	

Service & Support

13.5.3 Europa (Ost) - Europe (East)

vom Ausland: (0) nach Landeskennziffer weglassen

from abroad: don't dial (0) after country code

<p>Czech Republic - Tschechien</p> <p>Bosch -Rexroth, spol.s.r.o. Hviezdoslavova 5 627 00 Brno Tel.: +420 (0)5 48 126 358 Fax: +420 (0)5 48 126 112</p>	<p>Czech Republic - Tschechien</p> <p>DEL a.s. Strojirenská 38 591 01 Zdar nad Sázavou Tel.: +420 566 64 3144 Fax: +420 566 62 1657</p>	<p>Hungary - Ungarn</p> <p>Bosch Rexroth Kft. Angol utca 34 1149 Budapest Tel.: +36 (1) 422 3200 Fax: +36 (1) 422 3201</p>	<p>Poland – Polen</p> <p>Bosch Rexroth Sp.zo.o. ul. Staszica 1 05-800 Pruszków Tel.: +48 22 738 18 00 – service: +48 22 738 18 46 Fax: +48 22 758 87 35 – service: +48 22 738 18 42</p>
<p>Poland – Polen</p> <p>Bosch Rexroth Sp.zo.o. Biuro Poznan ul. Dabrowskiego 81/85 60-529 Poznan Tel.: +48 061 847 64 62 /-63 Fax: +48 061 847 64 02</p>	<p>Romania - Rumänien</p> <p>East Electric S.R.L. Bdul Basarabia no.250, sector 3 73429 Bucuresti Tel./Fax:: +40 (0)21 255 35 07 +40 (0)21 255 77 13 Fax: +40 (0)21 725 61 21 eastel@rdsnet.ro</p>	<p>Romania - Rumänien</p> <p>Bosch Rexroth Sp.zo.o. Str. Drobety nr. 4-10, app. 14 70258 Bucuresti, Sector 2 Tel.: +40 (0)1 210 48 25 +40 (0)1 210 29 50 Fax: +40 (0)1 210 29 52</p>	<p>Russia - Russland</p> <p>Bosch Rexroth OOO Wjatskaja ul. 27/15 127015 Moskau Tel.: +7-095-785 74 78 +7-095 785 74 79 Fax: +7 095 785 74 77 laura.kanina@boschrexroth.ru</p>
<p>Russia - Russland</p> <p>ELMIS 10, Internationalnaya 246640 Gomel, Belarus Tel.: +375/ 232 53 42 70 +375/ 232 53 21 69 Fax: +375/ 232 53 37 69 elmis_ltd@yahoo.com</p>	<p>Turkey - Türkei</p> <p>Bosch Rexroth Otomasyon San & Tic. A..S. Fevzi Cakmak Cad No. 3 34630 Sefaköy Istanbul Tel.: +90 212 541 60 70 Fax: +90 212 599 34 07</p>	<p>Turkey - Türkei</p> <p>Servo Kontrol Ltd. Sti. Perpa Ticaret Merkezi B Blok Kat: 11 No: 1609 80270 Okmeydani-Istanbul Tel: +90 212 320 30 80 Fax: +90 212 320 30 81 remzi.sali@servokontrol.com www.servokontrol.com</p>	<p>Slovenia - Slowenien</p> <p>DOMEL Otoki 21 64 228 Zelezniki Tel.: +386 5 5117 152 Fax: +386 5 5117 225 brane.ozebek@domel.si</p>

Service & Support

13.5.4 Afrika, Asien, Australien (inkl. Pazifischer Raum) - Africa, Asia, Australia (incl. Pacific Rim)

<p>Australia - Australien</p> <p>AIMS - Australian Industrial Machinery Services Pty. Ltd. 28 Westside Drive Laverton North Vic 3026 Melbourne</p> <p>Tel.: +61 3 93 14 3321 Fax: +61 3 93 14 3329 Hotlines: +61 3 93 14 3321 +61 4 19 369 195 enquires@aimservices.com.au</p>	<p>Australia - Australien</p> <p>Bosch Rexroth Pty. Ltd. No. 7, Endeavour Way Braeside Victoria, 31 95 Melbourne</p> <p>Tel.: +61 3 95 80 39 33 Fax: +61 3 95 80 17 33 mel@rexroth.com.au</p>	<p>China</p> <p>Shanghai Bosch Rexroth Hydraulics & Automation Ltd. Waigaoqiao, Free Trade Zone No.122, Fu Te Dong Yi Road Shanghai 200131 - P.R.China</p> <p>Tel.: +86 21 58 66 30 30 Fax: +86 21 58 66 55 23 richard.yang_sh@boschrexroth.com.cn qf.zhu_sh@boschrexroth.com.cn</p>	<p>China</p> <p>Shanghai Bosch Rexroth Hydraulics & Automation Ltd. 4/f, Marine Tower No.1, Pudong Avenue Shanghai 200120 - P.R.China</p> <p>Tel.: +86 21 68 86 15 88 Fax: +86 21 58 40 65 77</p>
<p>China</p> <p>Bosch Rexroth China Ltd. 15/F China World Trade Center 1, Jianguomenwai Avenue Beijing 100004, P.R.China</p> <p>Tel.: +86 10 65 05 03 80 Fax: +86 10 65 05 03 79</p>	<p>China</p> <p>Bosch Rexroth China Ltd. Guangzhou Repres. Office Room 1014-1016, Metro Plaza, Tian He District, 183 Tian He Bei Rd Guangzhou 510075, P.R.China</p> <p>Tel.: +86 20 8755-0030 +86 20 8755-0011 Fax: +86 20 8755-2387</p>	<p>China</p> <p>Bosch Rexroth (China) Ltd. A-5F., 123 Lian Shan Street Sha He Kou District Dalian 116 023, P.R.China</p> <p>Tel.: +86 411 46 78 930 Fax: +86 411 46 78 932</p>	<p>China</p> <p>Melchers GmbH BRC-SE, Tightening & Press-fit 13 Floor Est Ocean Centre No.588 Yanan Rd. East 65 Yanan Rd. West Shanghai 200001</p> <p>Tel.: +86 21 6352 8848 Fax: +86 21 6351 3138</p>
<p>Hongkong</p> <p>Bosch Rexroth (China) Ltd. 6th Floor, Yeung Yiu Chung No.6 Ind Bldg. 19 Cheung Shun Street Cheung Sha Wan, Kowloon, Hongkong</p> <p>Tel.: +852 22 62 51 00 Fax: +852 27 41 33 44 alexis.siu@boschrexroth.com.hk</p>	<p>India - Indien</p> <p>Bosch Rexroth (India) Ltd. Electric Drives & Controls Plot. No.96, Phase III Peenya Industrial Area Bangalore – 560058</p> <p>Tel.: +91 80 51 17 0-211...-218 Fax: +91 80 83 94 345 +91 80 83 97 374 mohanvelu.t@boschrexroth.co.in</p>	<p>India - Indien</p> <p>Bosch Rexroth (India) Ltd. Electric Drives & Controls Advance House, II Floor Ark Industrial Compound Narol Naka, Makwana Road Andheri (East), Mumbai - 400 059</p> <p>Tel.: +91 22 28 56 32 90 +91 22 28 56 33 18 Fax: +91 22 28 56 32 93 singh.op@boschrexroth.co.in</p>	<p>India - Indien</p> <p>Bosch Rexroth (India) Ltd. S-10, Green Park Extension New Delhi – 110016</p> <p>Tel.: +91 11 26 56 65 25 +91 11 26 56 65 27 Fax: +91 11 26 56 68 87 koul.rp@boschrexroth.co.in</p>
<p>Indonesia - Indonesien</p> <p>PT. Bosch Rexroth Building # 202, Cilandak Commercial Estate Jl. Cilandak KKO, Jakarta 12560</p> <p>Tel.: +62 21 7891169 (5 lines) Fax: +62 21 7891170 - 71 rudu.karimun@boschrexroth.co.id</p>	<p>Japan</p> <p>Bosch Rexroth Automation Corp. Service Center Japan Yutakagaoka 1810, Meito-ku, NAGOYA 465-0035, Japan</p> <p>Tel.: +81 52 777 88 41 +81 52 777 88 53 +81 52 777 88 79 Fax: +81 52 777 89 01</p>	<p>Japan</p> <p>Bosch Rexroth Automation Corp. Electric Drives & Controls 2F, I.R. Building Nakamachidai 4-26-44, Tsuzuki-ku YOKOHAMA 224-0041, Japan</p> <p>Tel.: +81 45 942 72 10 Fax: +81 45 942 03 41</p>	<p>Korea</p> <p>Bosch Rexroth-Korea Ltd. Electric Drives and Controls Bongwoo Bldg. 7FL, 31-7, 1Ga Jangchoong-dong, Jung-gu Seoul, 100-391</p> <p>Tel.: +82 234 061 813 Fax: +82 222 641 295</p>
<p>Korea</p> <p>Bosch Rexroth-Korea Ltd. 1515-14 Dadae-Dong, Saha-gu Electric Drives & Controls Pusan Metropolitan City, 604-050</p> <p>Tel.: +82 51 26 00 741 Fax: +82 51 26 00 747 eunkyoung.kim@boschrexroth.co.kr</p>	<p>Malaysia</p> <p>Bosch Rexroth Sdn.Bhd. 11, Jalan U8/82, Seksyen U8 40150 Shah Alam Selangor, Malaysia</p> <p>Tel.: +60 3 78 44 80 00 Fax: +60 3 78 45 48 00 hockhwa@hotmail.com rexroth1@tm.net.my</p>	<p>Singapore - Singapur</p> <p>Bosch Rexroth Pte Ltd 15D Tuas Road Singapore 638520</p> <p>Tel.: +65 68 61 87 33 Fax: +65 68 61 18 25 sanjay.nemade@boschrexroth.com.sg</p>	<p>South Africa - Südafrika</p> <p>TECTRA Automation (Pty) Ltd. 71 Watt Street, Meadowdale Edenvale 1609</p> <p>Tel.: +27 11 971 94 00 Fax: +27 11 971 94 40 Hotline: +27 82 903 29 23 georgv@tectra.co.za</p>
<p>Taiwan</p> <p>Bosch Rexroth Co., Ltd. Taichung Branch 1F., No. 29, Fu-Ann 5th Street, Xi-Tun Area, Taichung City Taiwan, R.O.C.</p> <p>Tel.: +886 - 4 -23580400 Fax: +886 - 4 -23580402 charlie.chen@boschrexroth.com.tw jim.lin@boschrexroth.com.tw david.lai@boschrexroth.com.tw</p>	<p>Thailand</p> <p>NC Advance Technology Co. Ltd. 59/76 Moo 9 Ramintra road 34 Tharang, Bangkokhen, Bangkok 10230</p> <p>Tel.: +66 2 943 70 62 +66 2 943 71 21 Fax: +66 2 509 23 62 Hotline: +66 1 984 61 52 sonkawin@hotmail.com</p>		

Service & Support

13.5.5 Nordamerika - North America

USA Headquarters - Hauptniederlassung Bosch Rexroth Corporation Electric Drives & Controls 5150 Prairie Stone Parkway Hoffman Estates, IL 60192-3707 Tel.: +1 847 6 45 36 00 Fax: +1 847 6 45 62 01 servicebrc@boschrexroth-us.com repairbrc@boschrexroth-us.com	USA Central Region - Mitte Bosch Rexroth Corporation Electric Drives & Controls Central Region Technical Center 1701 Harmon Road Auburn Hills, MI 48326 Tel.: +1 248 3 93 33 30 Fax: +1 248 3 93 29 06	USA Southeast Region - Südwest Bosch Rexroth Corporation Electric Drives & Controls Southeastern Technical Center 3625 Swiftwater Park Drive Suwanee, Georgia 30124 Tel.: +1 770 9 32 32 00 Fax: +1 770 9 32 19 03	USA SERVICE-HOTLINE - 7 days x 24hrs - +1-800-REX-ROTH +1 800 739 7684
USA East Region – Ost Bosch Rexroth Corporation Electric Drives & Controls Charlotte Regional Sales Office 14001 South Lakes Drive Charlotte, North Carolina 28273 Tel.: +1 704 5 83 97 62 +1 704 5 83 14 86	USA Northeast Region – Nordost Bosch Rexroth Corporation Electric Drives & Controls Northeastern Technical Center 99 Rainbow Road East Granby, Connecticut 06026 Tel.: +1 860 8 44 83 77 Fax: +1 860 8 44 85 95	USA West Region – West Bosch Rexroth Corporation 7901 Stoneridge Drive, Suite 220 Pleasant Hill, California 94588 Tel.: +1 925 227 10 84 Fax: +1 925 227 10 81	
Canada East - Kanada Ost Bosch Rexroth Canada Corporation Burlington Division 3426 Mainway Drive Burlington, Ontario Canada L7M 1A8 Tel.: +1 905 335 5511 Fax: +1 905 335 4184 Hotline: +1 905 335 5511 michael.moro@boschrexroth.ca	Canada West - Kanada West Bosch Rexroth Canada Corporation 5345 Goring St. Burnaby, British Columbia Canada V7J 1R1 Tel.: +1 604 205 5777 Fax: +1 604 205 6944 Hotline: +1 604 205 5777 david.gunby@boschrexroth.ca	Mexico Bosch Rexroth Mexico S.A. de C.V. Calle Neptuno 72 Unidad Ind. Vallejo 07700 Mexico, D.F. Tel.: +52 55 57 54 17 11 Fax: +52 55 57 54 50 73 mariofelipe.hernandez@boschrexroth.com.mx	Mexico Bosch Rexroth S.A. de C.V. Calle Argentina No 3913 Fracc. las Torres 64930 Monterrey, N.L. Tel.: +52 81 83 65 22 53 +52 81 83 65 89 11 +52 81 83 49 80 91 Fax: +52 81 83 65 52 80 mario.quiroga@boschrexroth.com.mx

13.5.6 Südamerika - South America

Argentina - Argentinien Bosch Rexroth S.A.I.C. "The Drive & Control Company" Rosario 2302 B1606DLD Carapachay Provincia de Buenos Aires Tel.: +54 11 4756 01 40 +54 11 4756 02 40 +54 11 4756 03 40 +54 11 4756 04 40 Fax: +54 11 4756 01 36 +54 11 4721 91 53 victor.jabif@boschrexroth.com.ar	Argentina - Argentinien NAKASE Servicio Tecnico CNC Calle 49, No. 5764/66 B1653AOX Villa Balester Provincia de Buenos Aires Tel.: +54 11 4768 36 43 Fax: +54 11 4768 24 13 Hotline: +54 11 155 307 6781 nakase@usa.net nakase@nakase.com gerencia@nakase.com (Service)	Brazil - Brasilien Bosch Rexroth Ltda. Av. Tégula, 888 Ponte Alta, Atibaia SP CEP 12942-440 Tel.: +55 11 4414 56 92 +55 11 4414 56 84 Fax sales: +55 11 4414 57 07 Fax serv.: +55 11 4414 56 86 alexandre.wittwer@rexroth.com.br	Brazil - Brasilien Bosch Rexroth Ltda. R. Dr.Humberto Pinheiro Vieira, 100 Distrito Industrial [Caixa Postal 1273] 89220-390 Joinville - SC Tel./Fax: +55 47 473 58 33 Mobil: +55 47 9974 6645 prochnow@zaz.com.br
Columbia - Kolumbien Reflutec de Colombia Ltda. Calle 37 No. 22-31 Santafé de Bogotá, D.C. Colombia Tel.: +57 1 368 82 67 +57 1 368 02 59 Fax: +57 1 268 97 37 reflutec@neutel.com.co reflutec@007mundo.com			

Bosch Rexroth AG
Electric Drives and Controls
P.O. Box 13 57
97803 Lohr, Germany
Bgm.-Dr.-Nebel-Str. 2
97816 Lohr, Germany
Phone +49 (0)93 52-40-50 60
Fax +49 (0)93 52-40-49 41
service.svc@boschrexroth.de
www.boschrexroth.com

